



-  Floor Coverings
-  Children Playgrounds
-  Sport Equipments
-  Urban Furnitures



# MONTE EXPRESS

2021 - 2022  
Product Catalogue



MONTE EXPRESS



# Success is Not a Coincidence

We are pleased to present our experience and know-how in Urban Furniture and Children's Playgrounds sector with the brand "Park World". In our products, we synthesize the aesthetic applications of our deep-rooted civilization and the architectural point of view.

Among our products; Modern seating, potted outdoor group group, training stations, direction boards, outdoor aquarium groups, outdoor table tennis, urban equipment, game and fitness groups, rubber and cast floor coverings, water parks just like your place.

We keep the security element at the highest level in Urban Furniture and Children's Play Systems. We achieve world standards with our environmentally friendly, natural, ergonomic products. Our products are designed and produced in such a way that all our people from 7 to 70 can benefit from the highest level, thus appealing to every segment.

While demonstrating our quality with the quality certificates and certificates we have, we continue to sign powerful projects with our energetic, strong, dynamic team and new ideas, and we continue to serve with our products that make a difference by combining the developing technology with years of experience, the understanding of aesthetics and security that constantly renews itself.

# İÇİNDEKİLER / CONTENTS

---



## (Outdoor Playgrounds)

1	World Series
9	Classic Series
15	Economic Series
21	Climbing Series
29	Spider Series
33	Forest Series
47	Train Series
51	Ship Series
55	Wooden Series
61	Disabled Series
65	Theme Series
71	Play Equipments
87	Wooden Theme Series

(Sport Equipments)

- 99** Fitness Equipments
- 103** Disabled Fitness Equipments
- 104** Metal Fitness Equipments
- 106** Barfix Equipments

(Urban Furnitures)

- 108** Wooden Benches
- 111** Pergolas
- 112** Picnic Tables
- 113** Wooden Trash Bins
- 115** Metal Trash Bins
- 119** Recycling Trash Bins

**121** Dog Training Equipment

**125** Softplay Products

**129** Field Equipments

**135** Project Application







With the Color Option you want  
Create Your Own World ...

**METAL**



**POLIETİLEN (POLYTHENE)**



**WORLD SERIES**

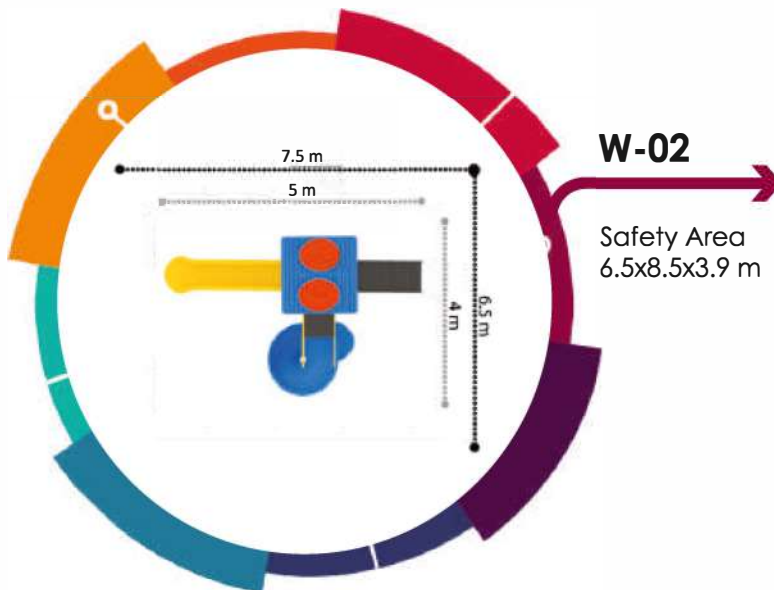





MONTE EXPRESS

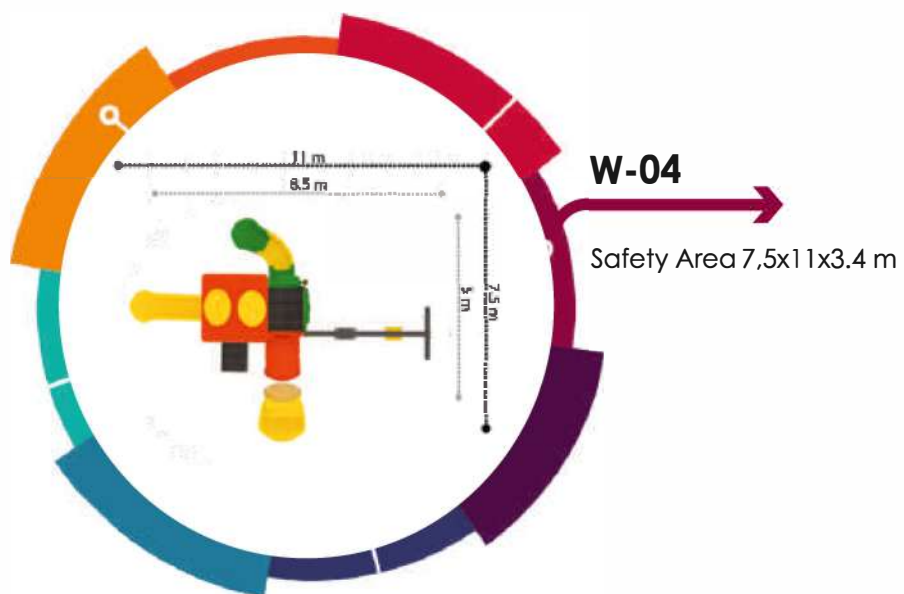
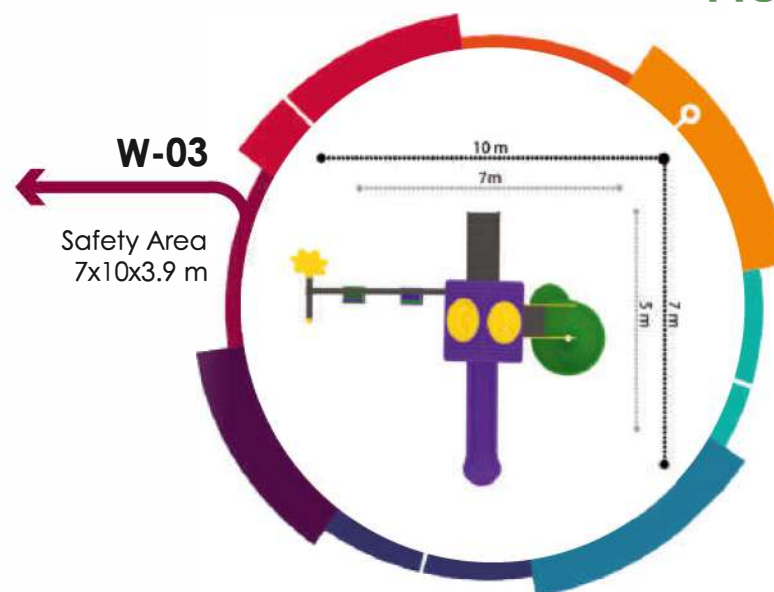

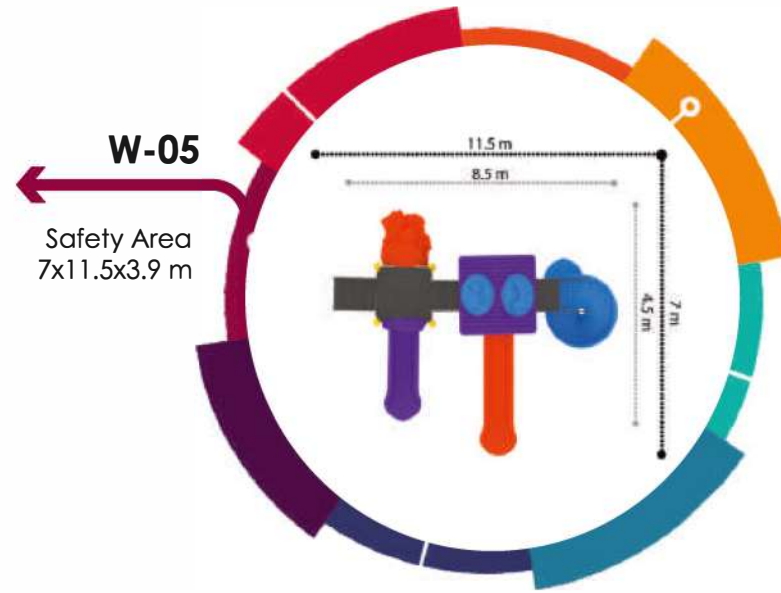



MONTE EXPRESS

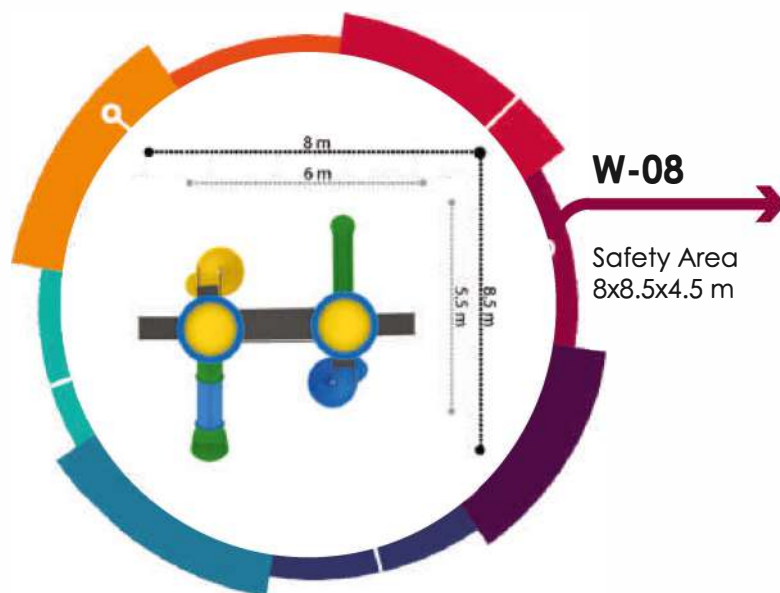
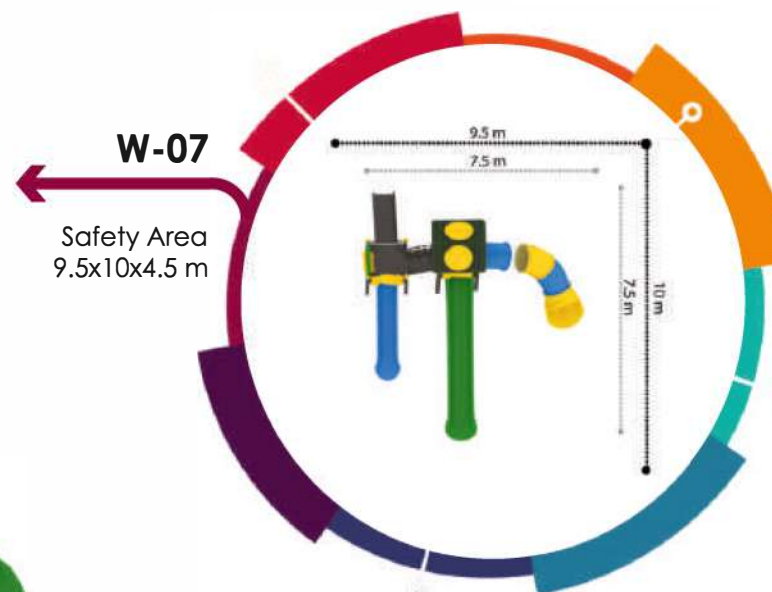



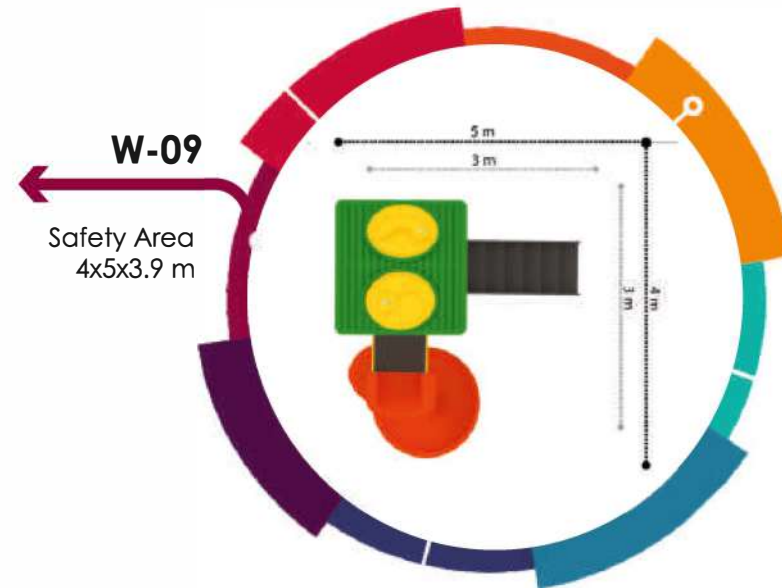

**W-09**  
Safety Area  
4x5x3.9 m

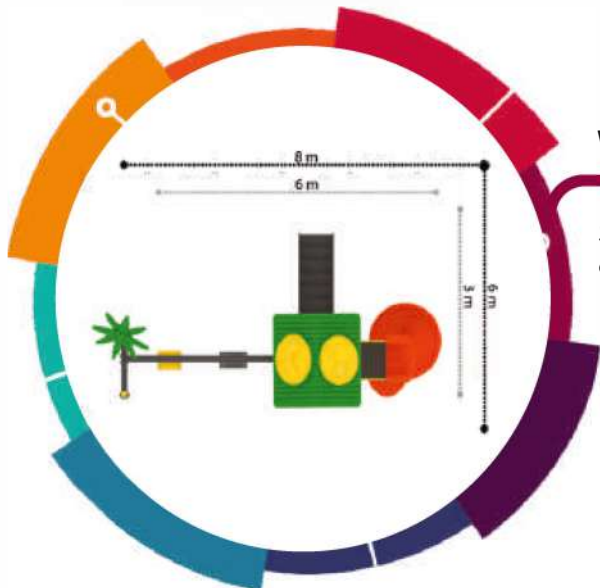

**W-10**  
Safety Area  
6x8x3.9 m





MONTE EXPRESS

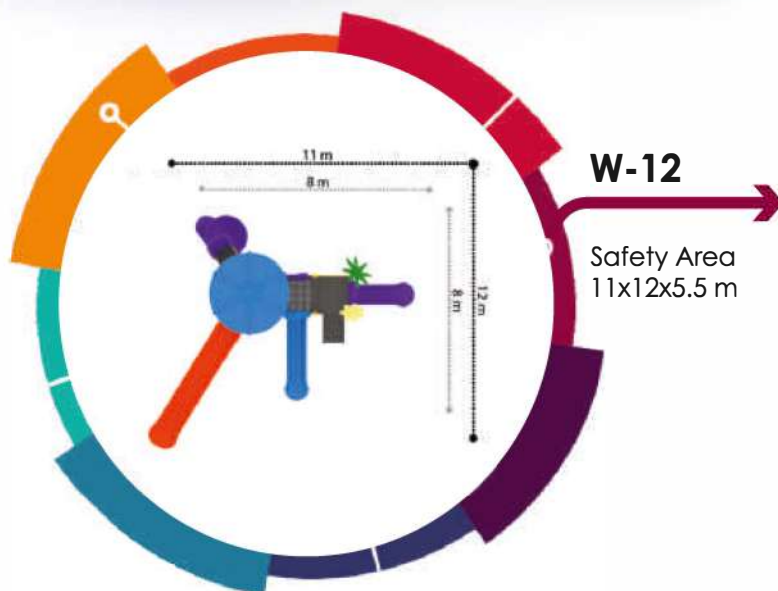
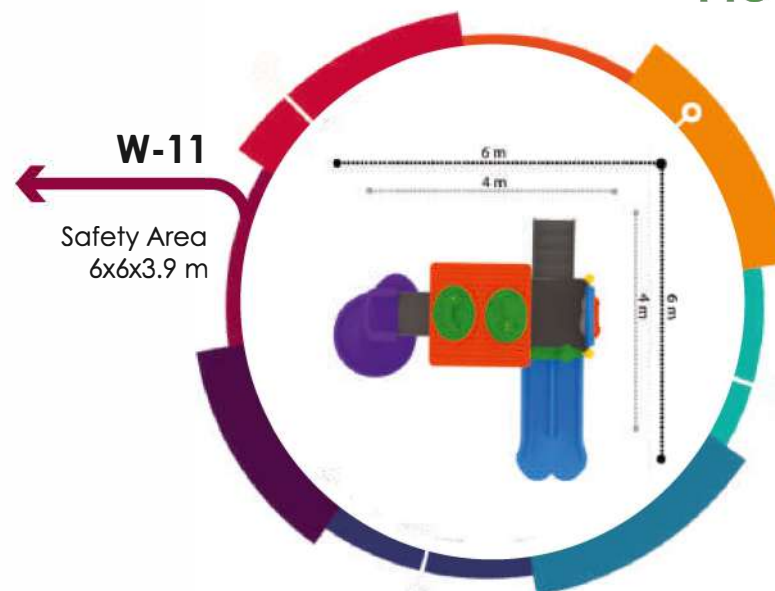

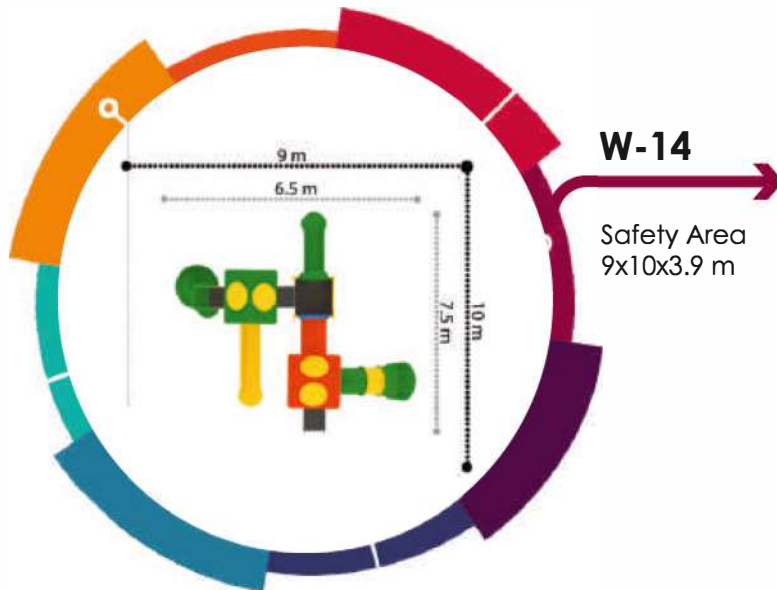
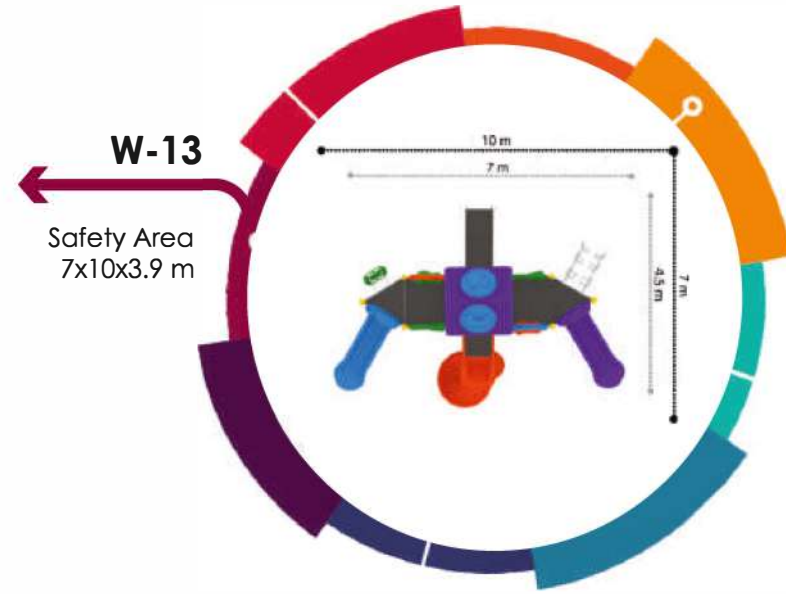





With the Color Option you want  
Create Your Own World ...

**METAL**



**POLIETILEN (POLYTHENE)**



**CLASSIC SERIES**

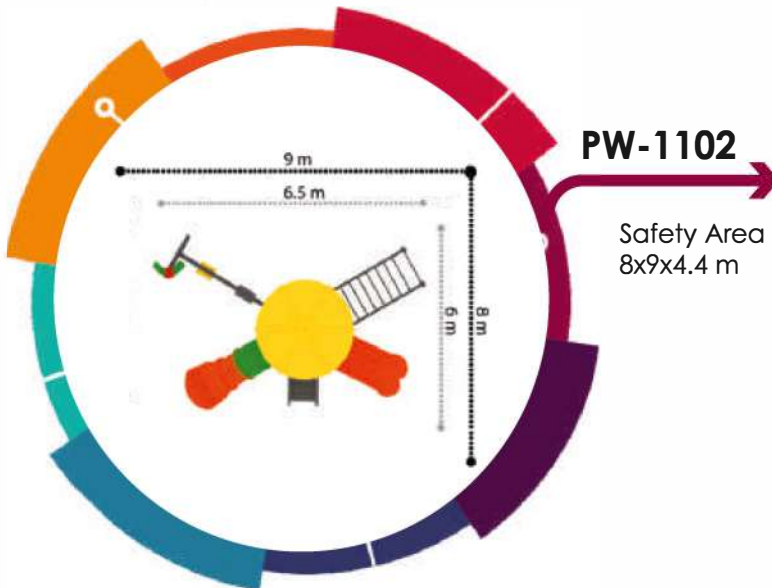
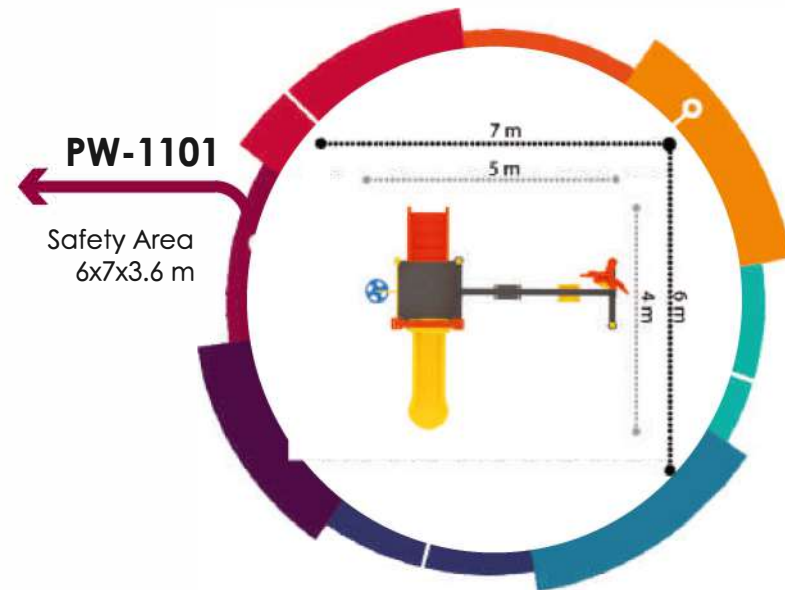



MONTE EXPRESS

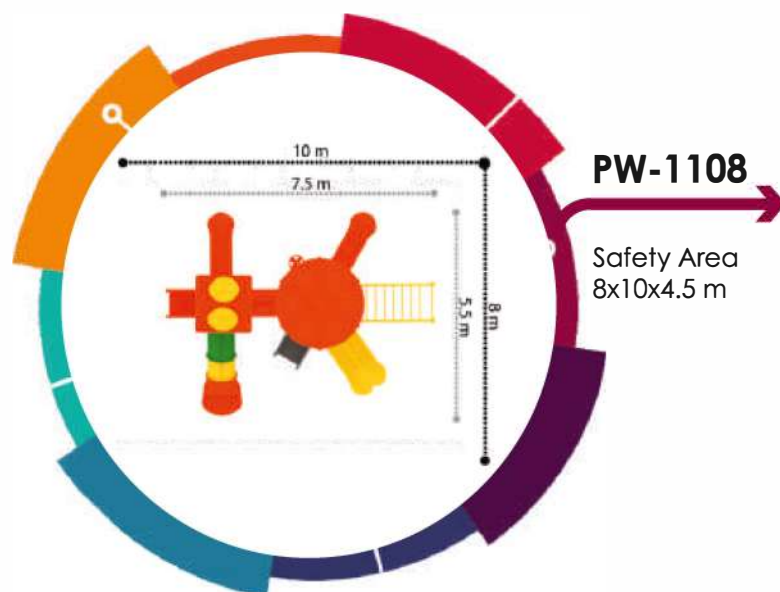
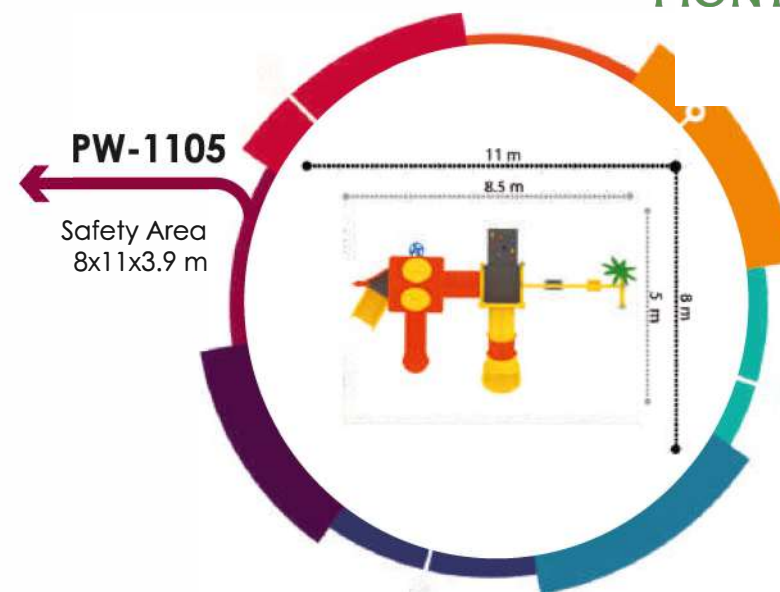



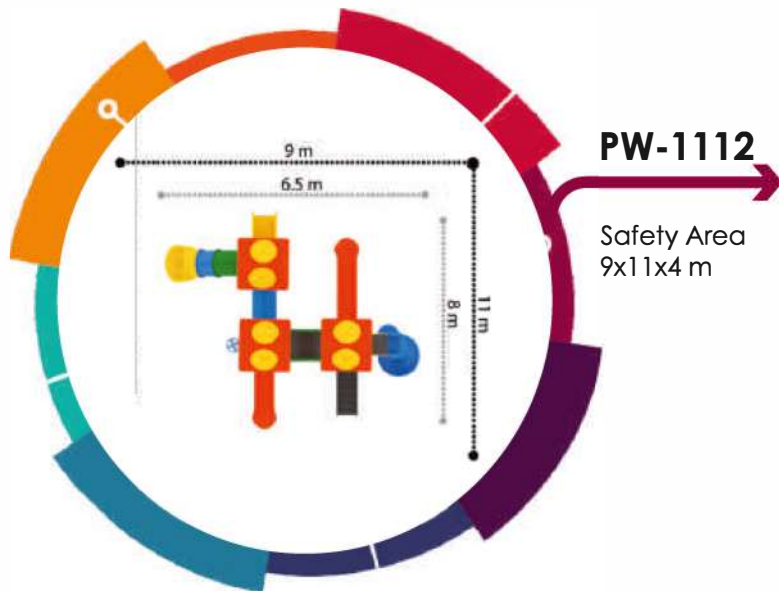
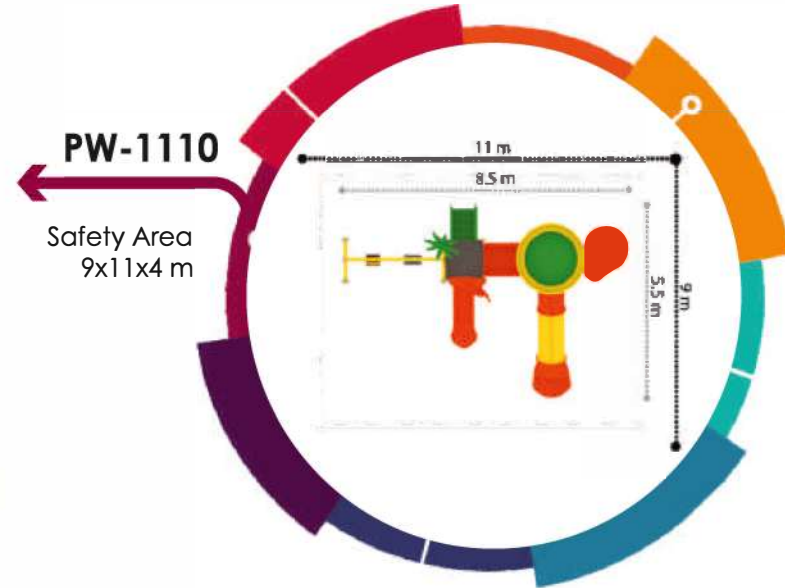



MONTE EXPRESS

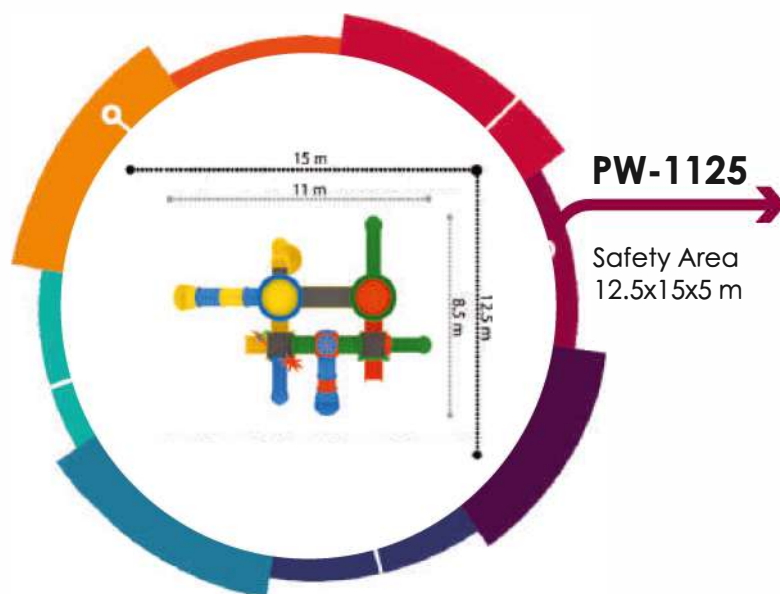
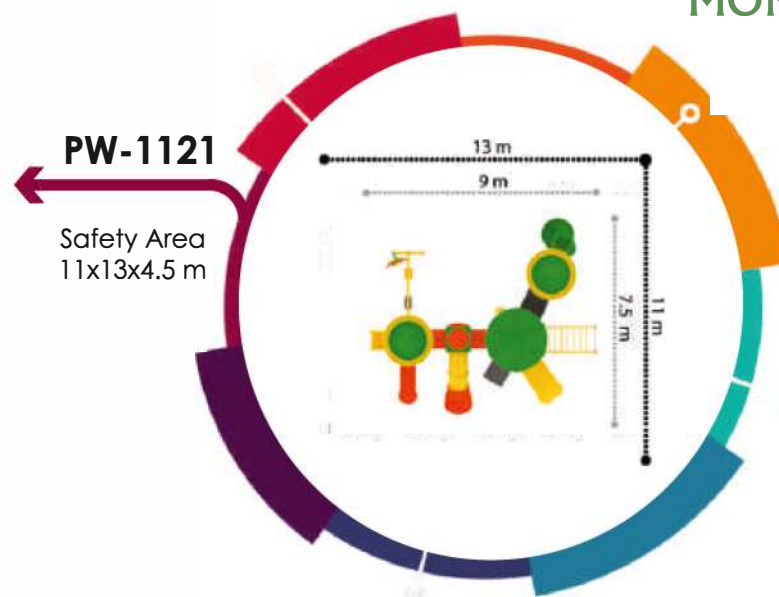



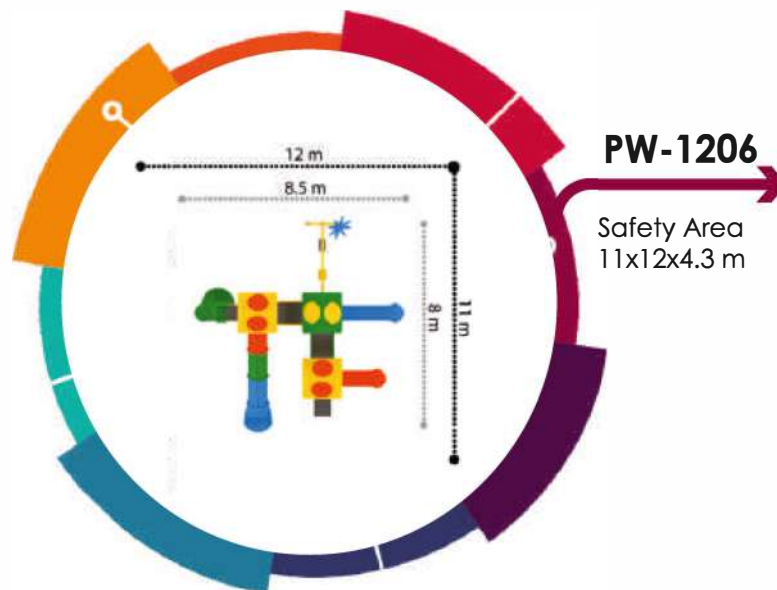
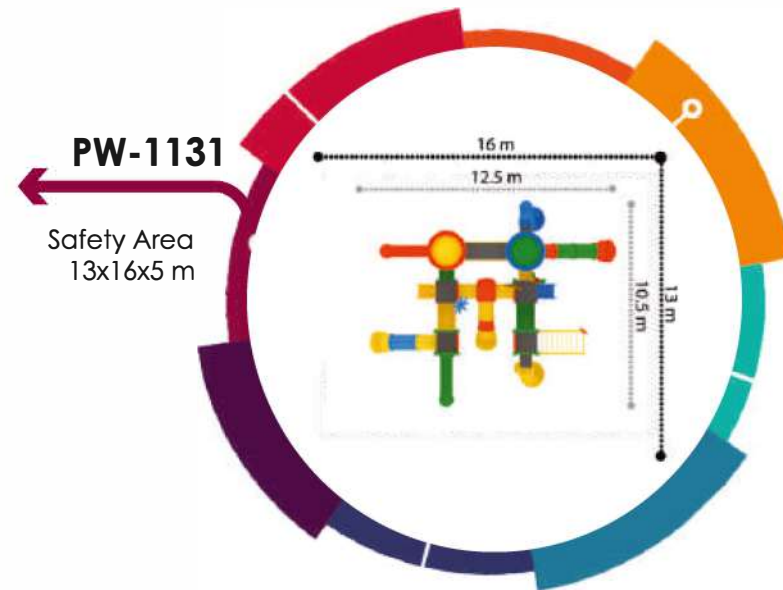



With the Color Option you want  
Create Your Own World ...

**METAL**



**POLIETILEN (POLYTHENE)**



**ECONOMIC SERIES**

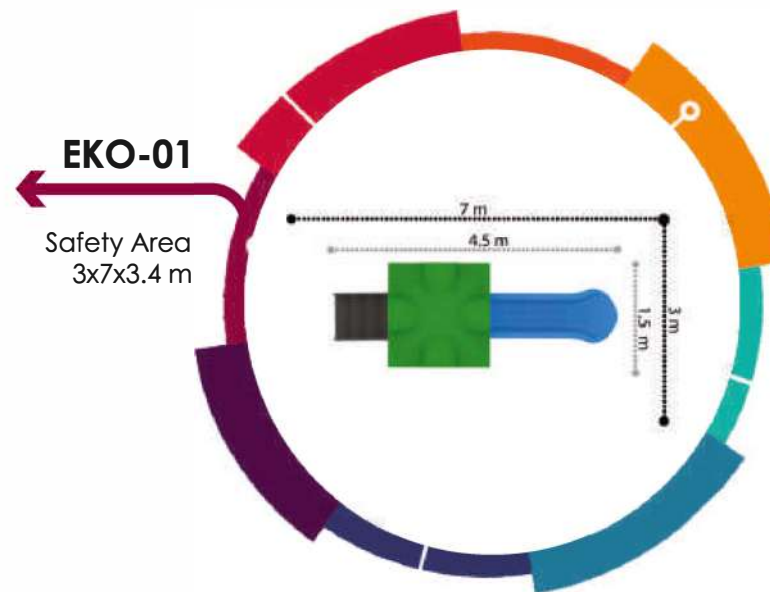





MONTE EXPRESS

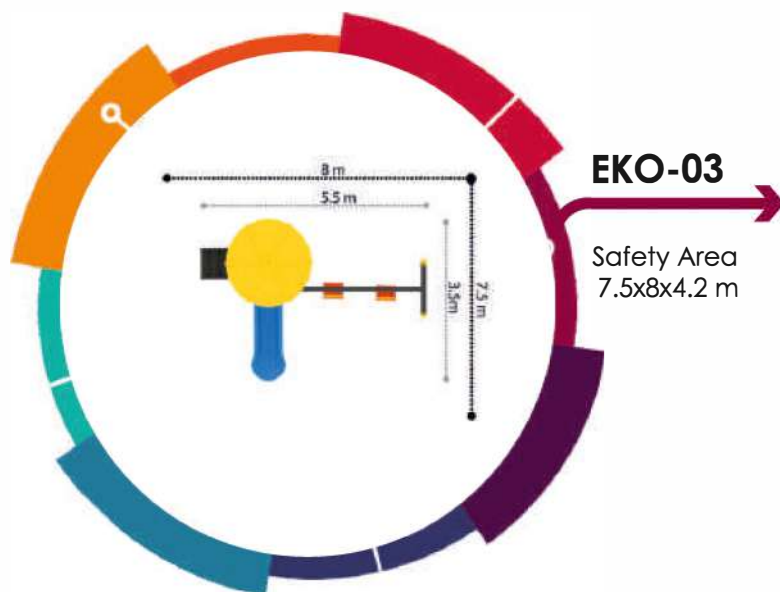
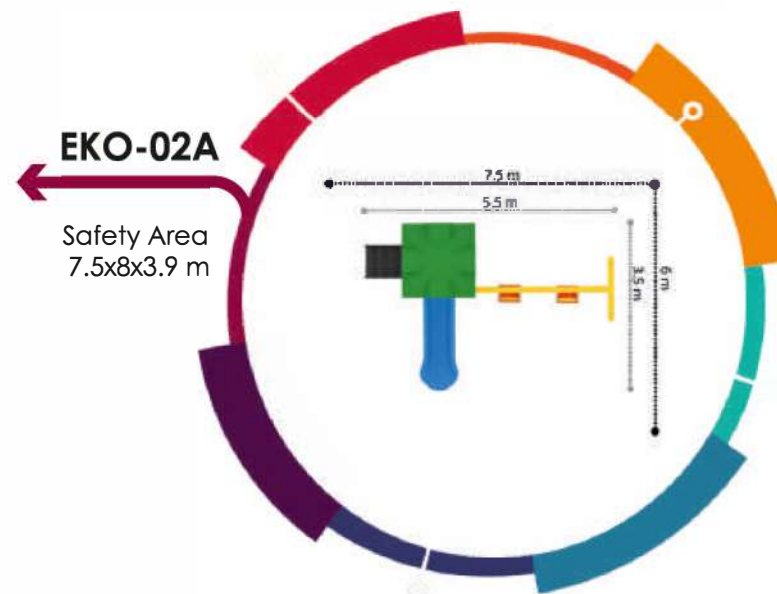





**EKO-05**

Safety Area  
8x8.5x3.9 m



**EKO-05A**

Safety Area  
8x8x3.9 m





MONTE EXPRESS

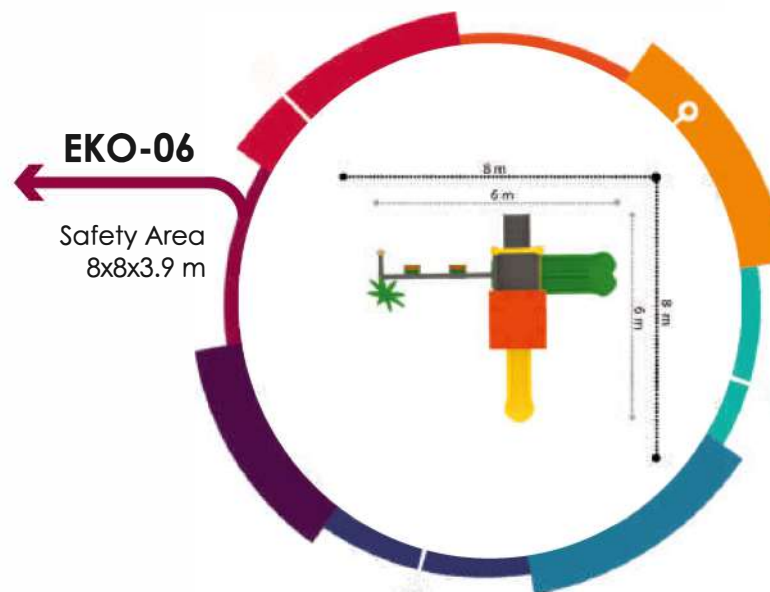

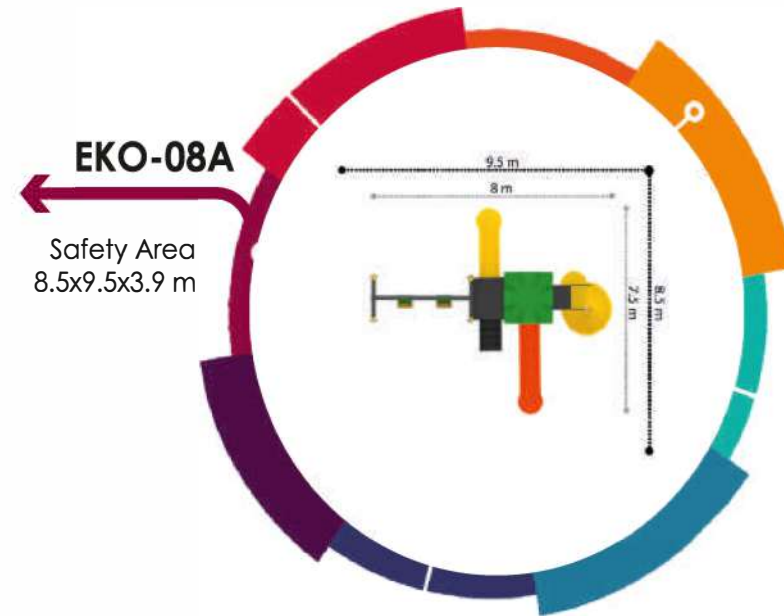



CLIMBING SERIES



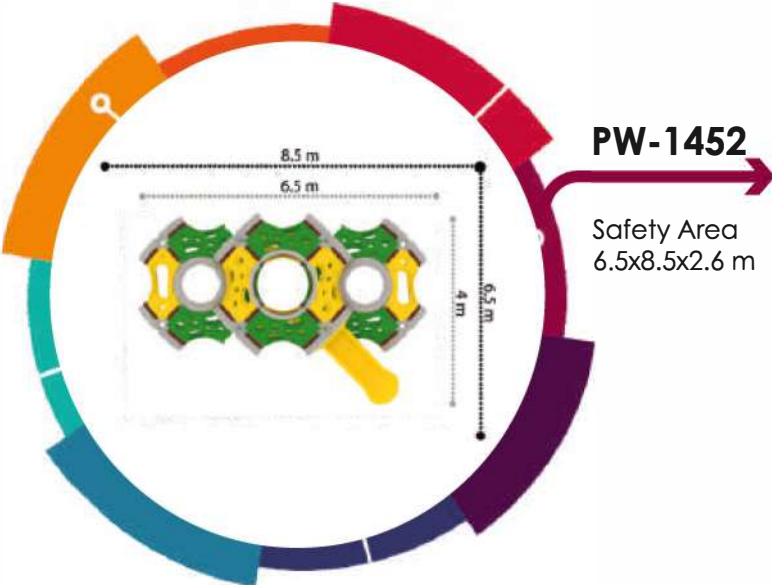
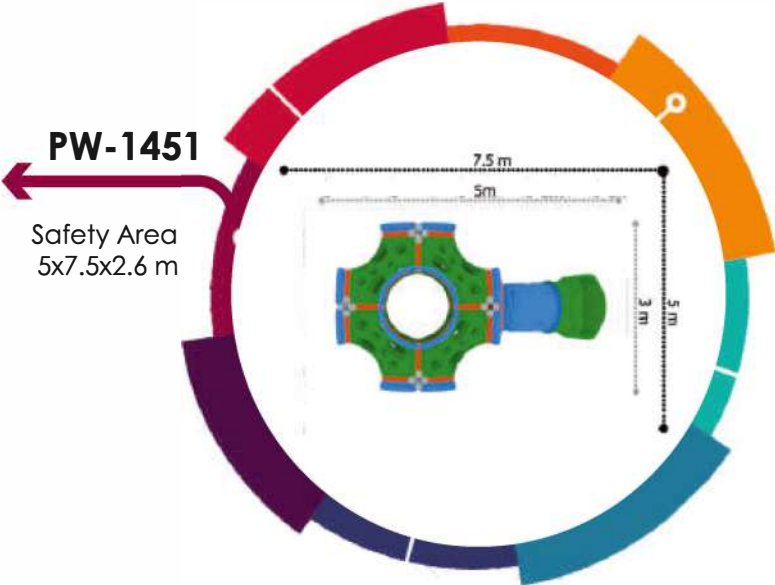



MONTE EXPRESS



**PW-1453**

Safety Area  
7x10x2.6 m

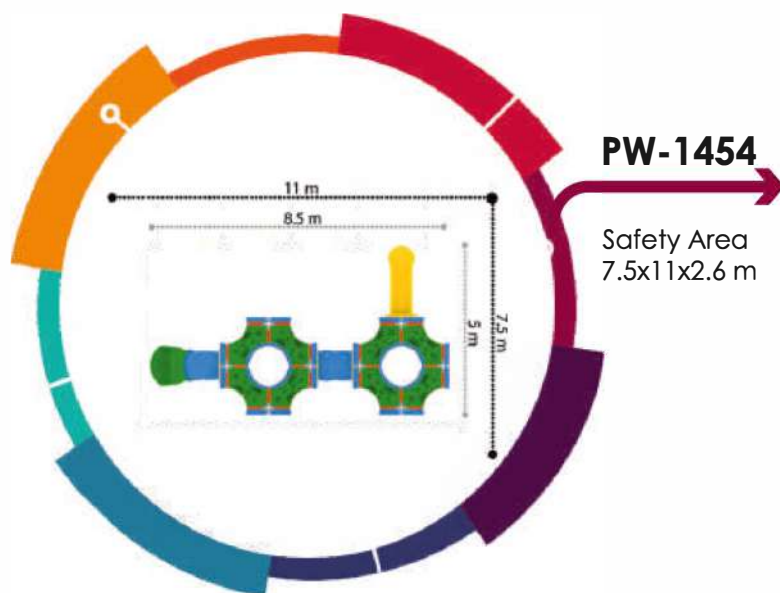
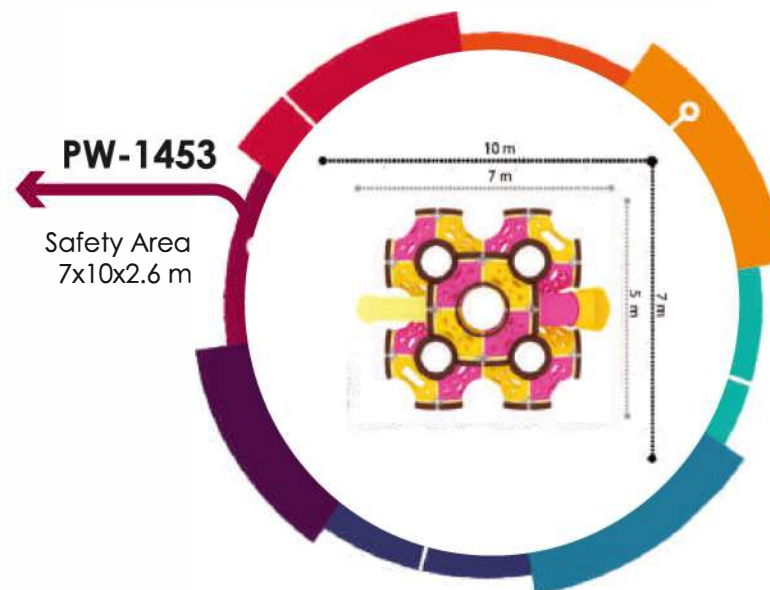

**PW-1454**

Safety Area  
7.5x11x2.6 m





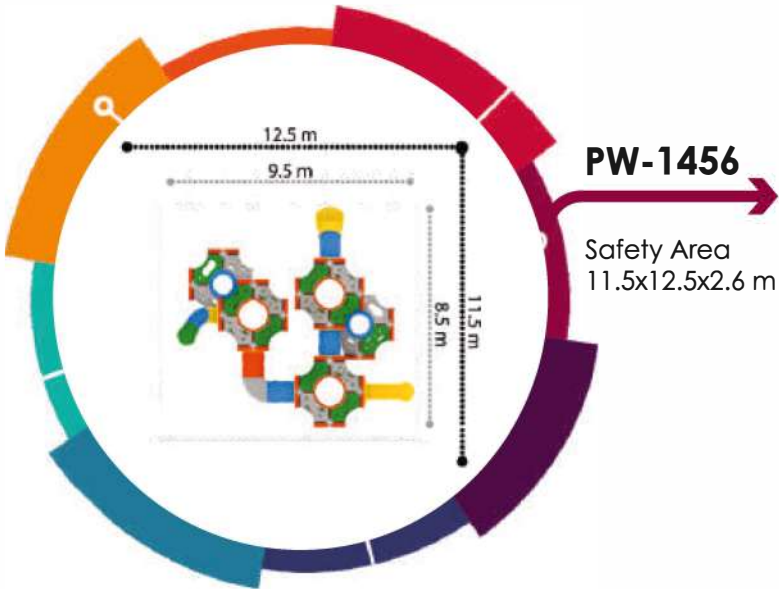
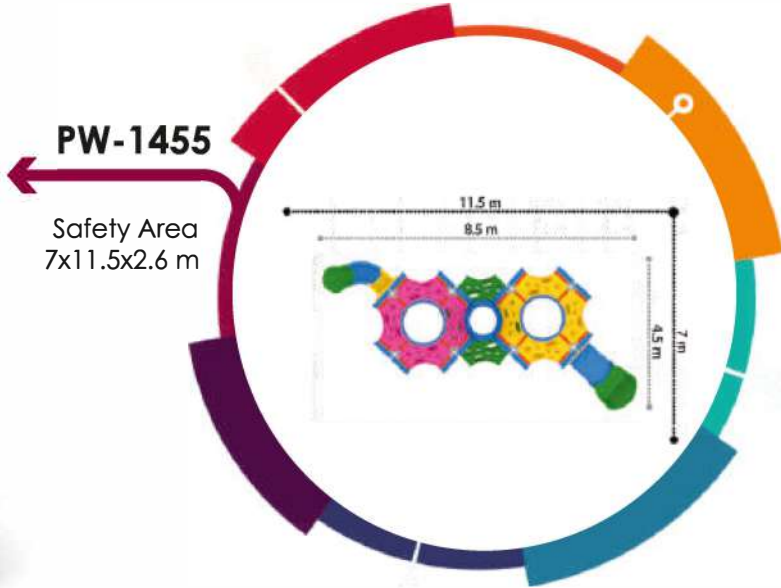



MONTE EXPRESS



**PW-1457**

Safety Area  
9.5x10x2.6 m

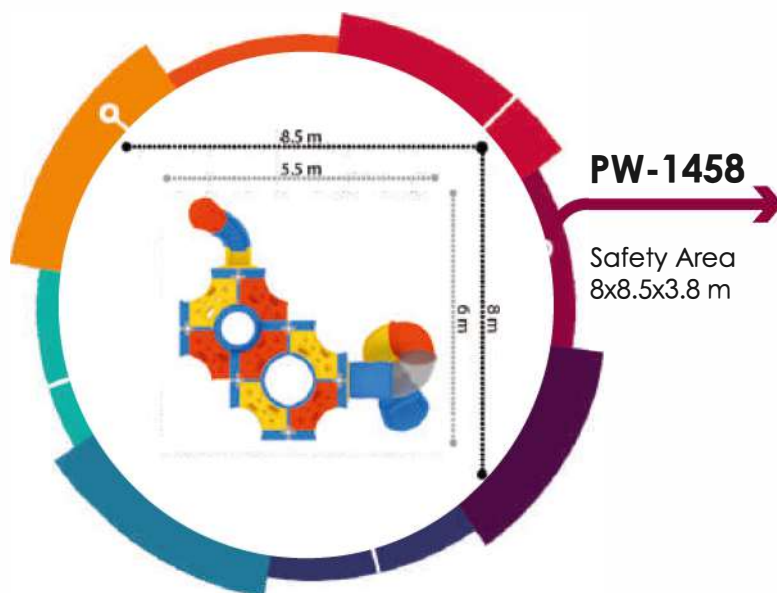
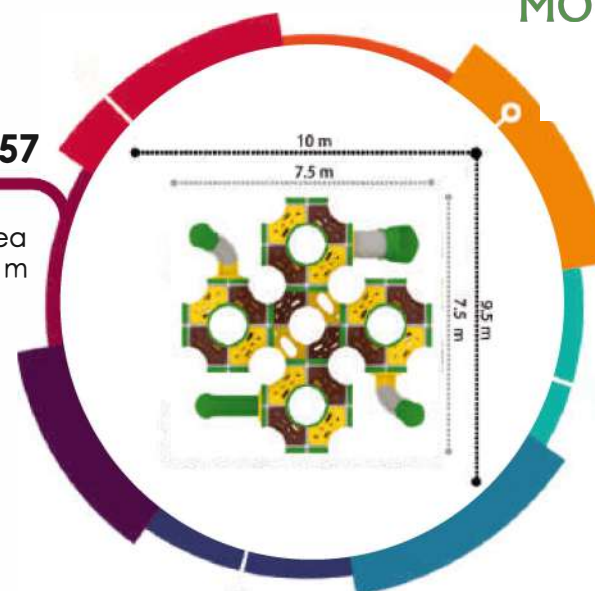

**PW-1458**

Safety Area  
8x8.5x3.8 m





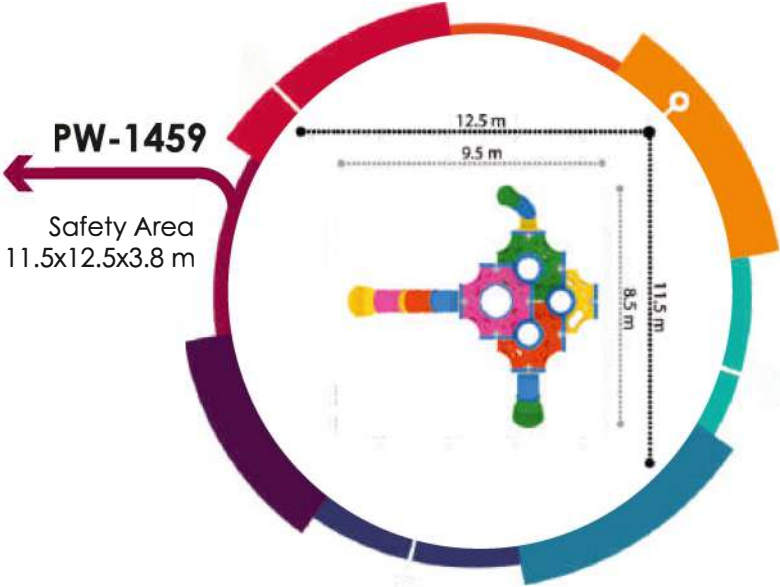

**PW-1459**  
Safety Area  
11.5x12.5x3.8 m

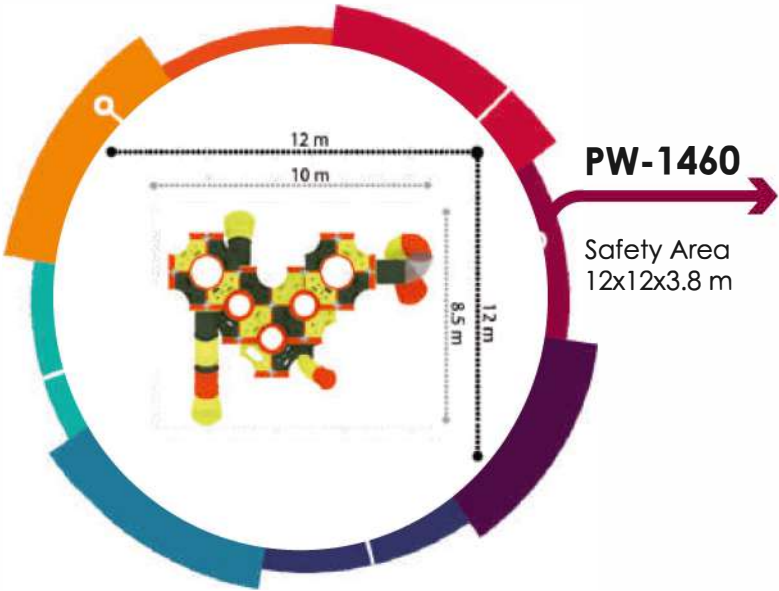

**PW-1460**  
Safety Area  
12x12x3.8 m







MONTE EXPRESS



**PW-1461**

Safety Area  
12x14x3.6 m

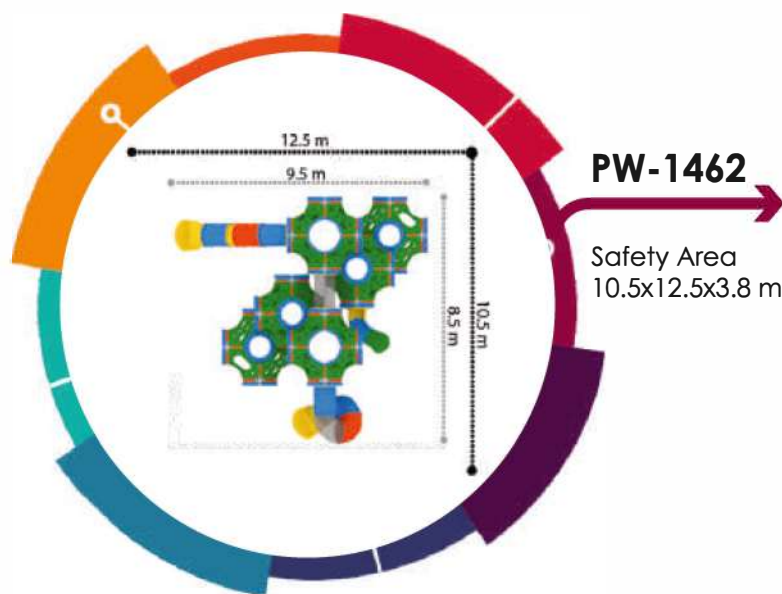
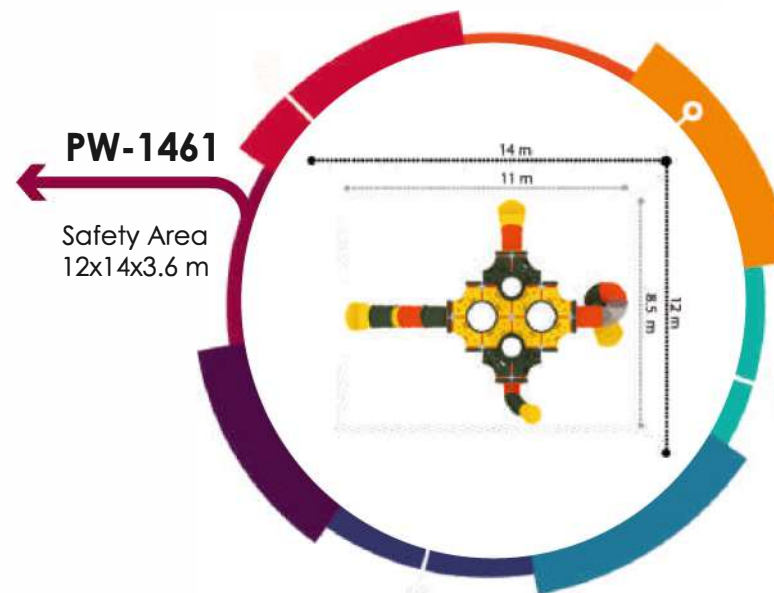

**PW-1462**

Safety Area  
10.5x12.5x3.8 m



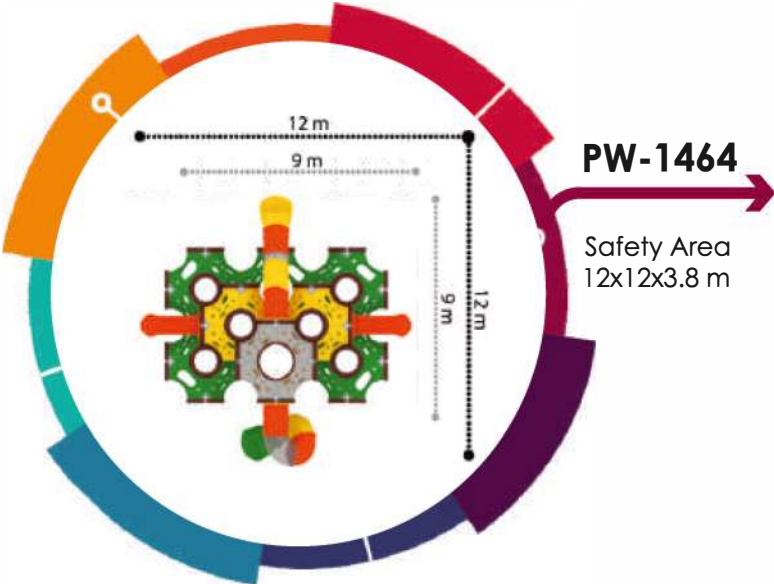
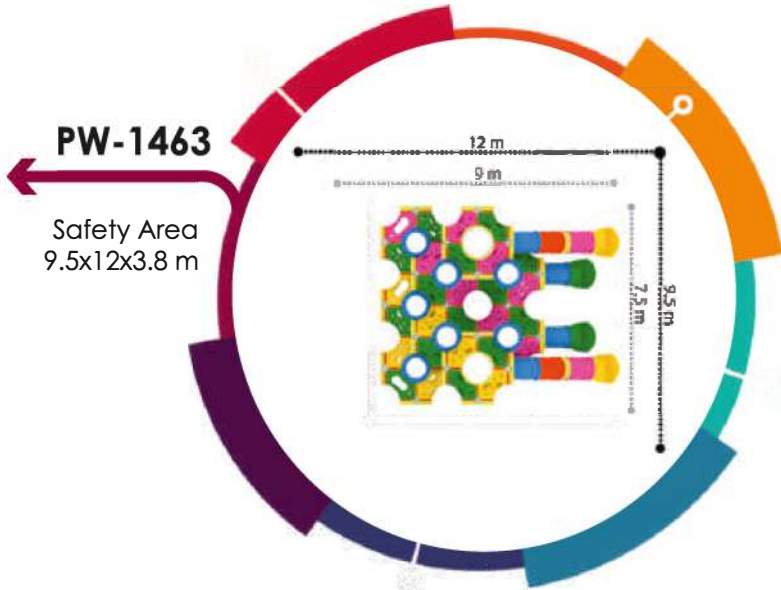



SPIDER SERIES





**PW-1552**

Safety Area  
11.5x15.5x3 m

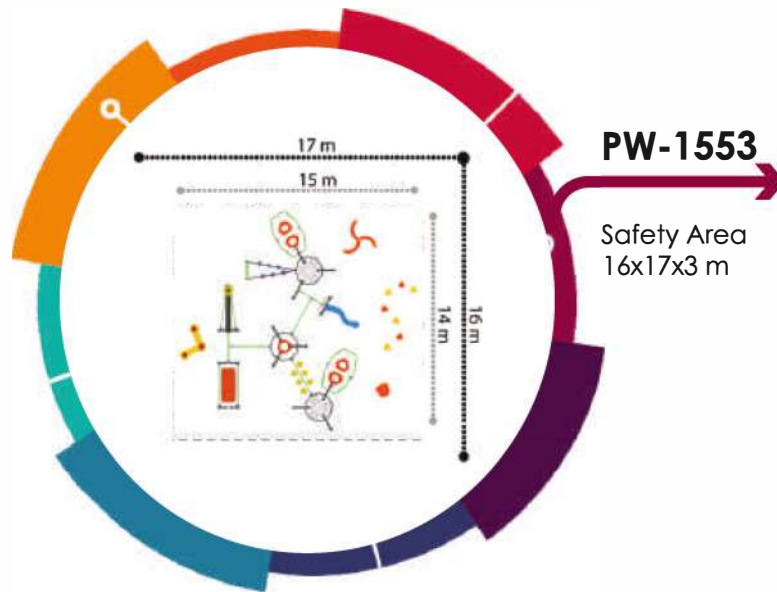
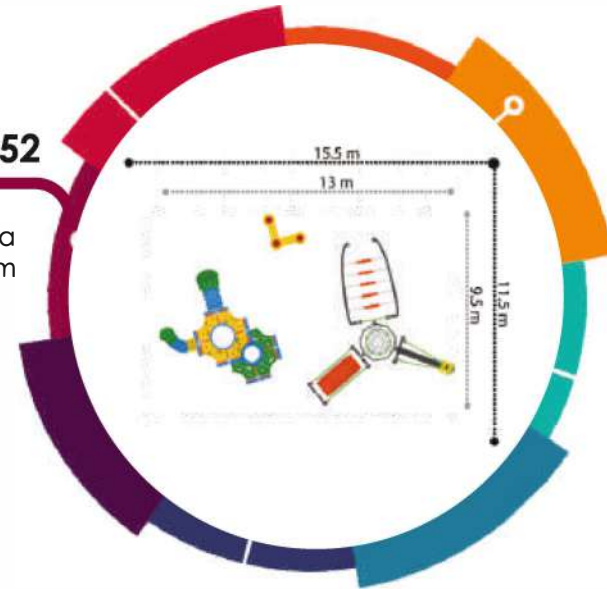

**PW-1553**

Safety Area  
16x17x3 m



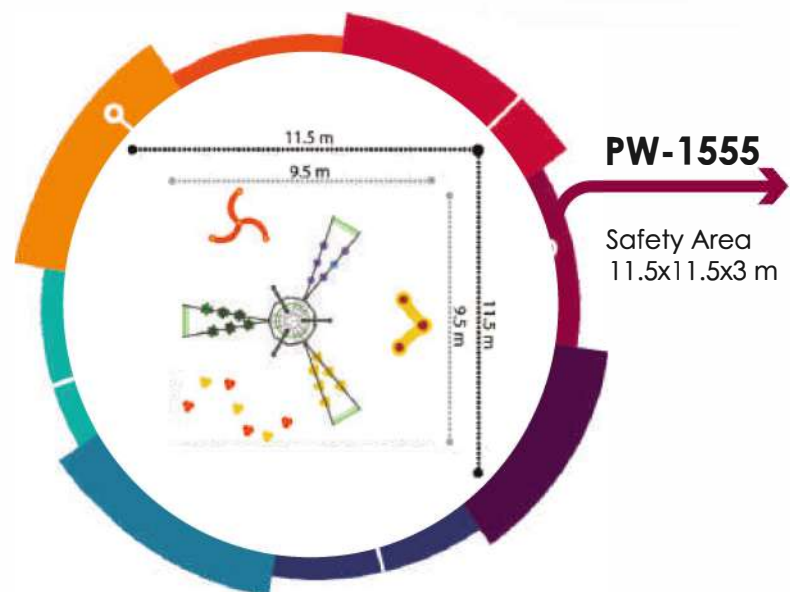
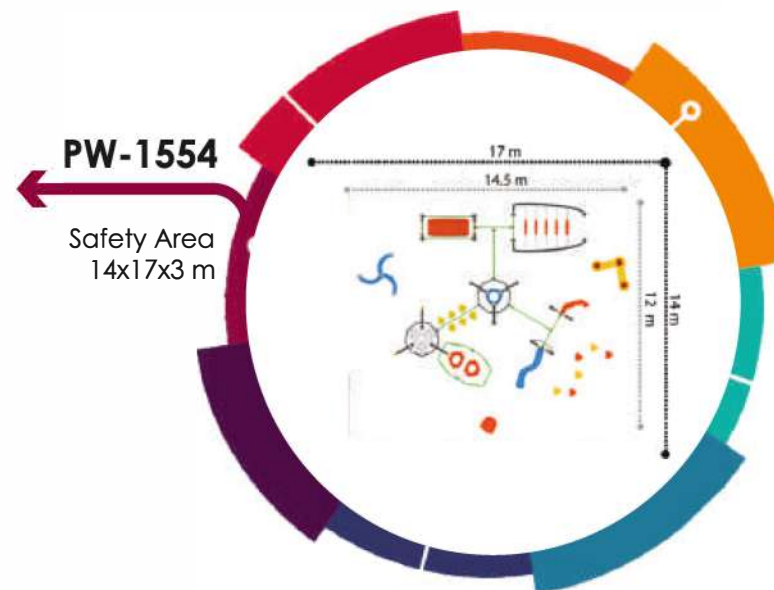



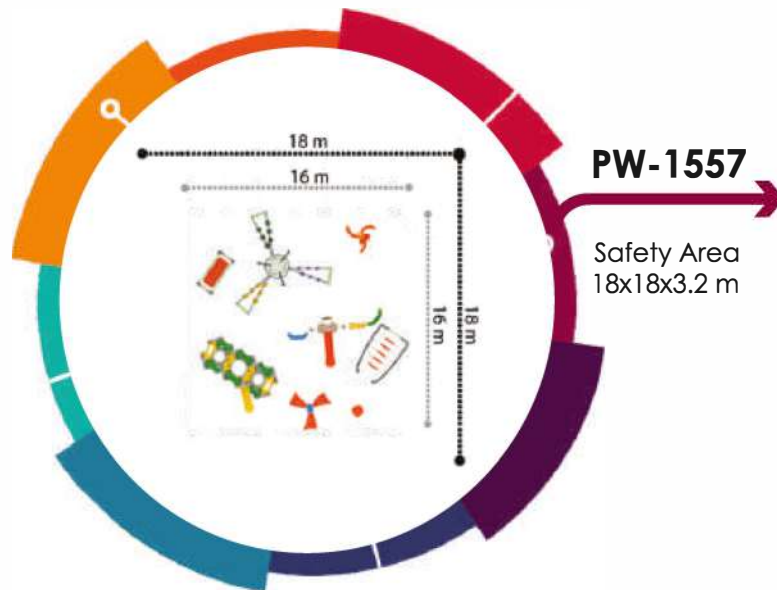
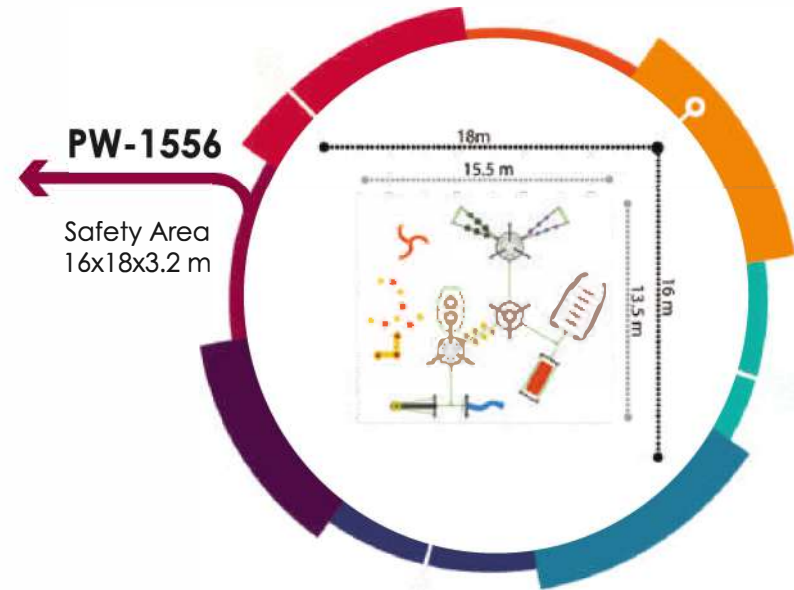





FOREST SERIES

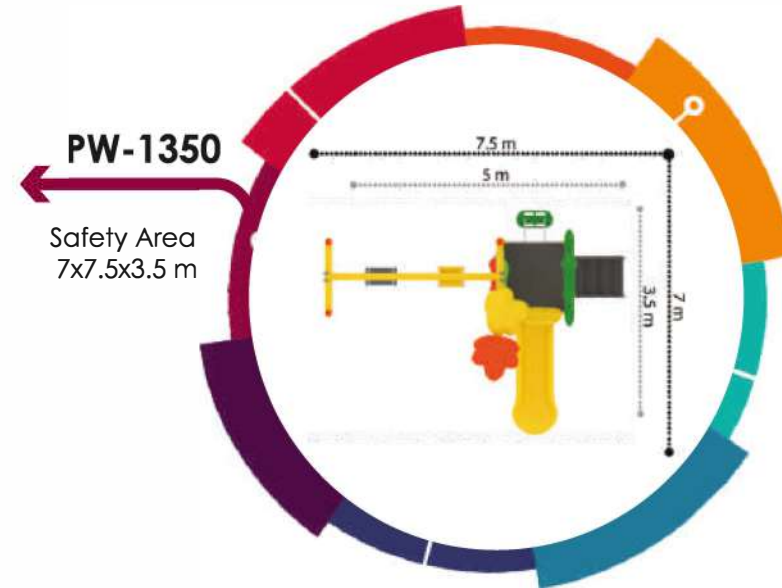





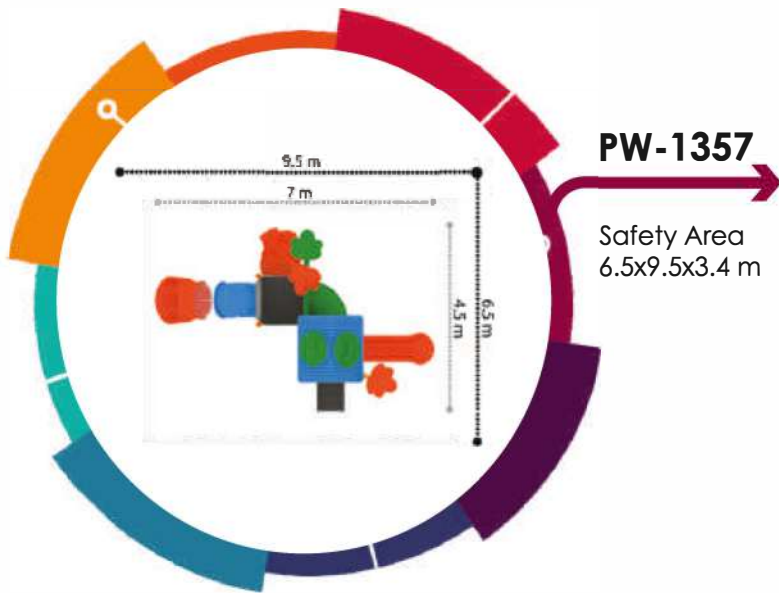
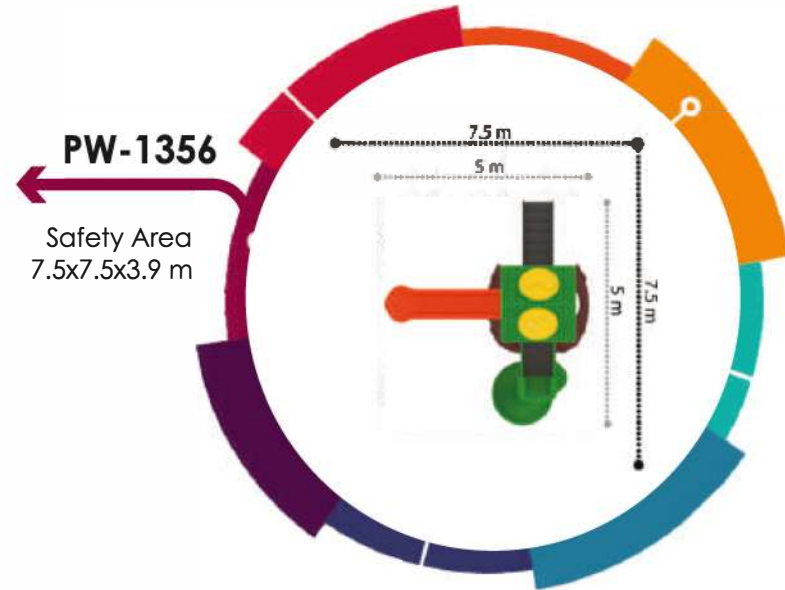



MONTE EXPRESS

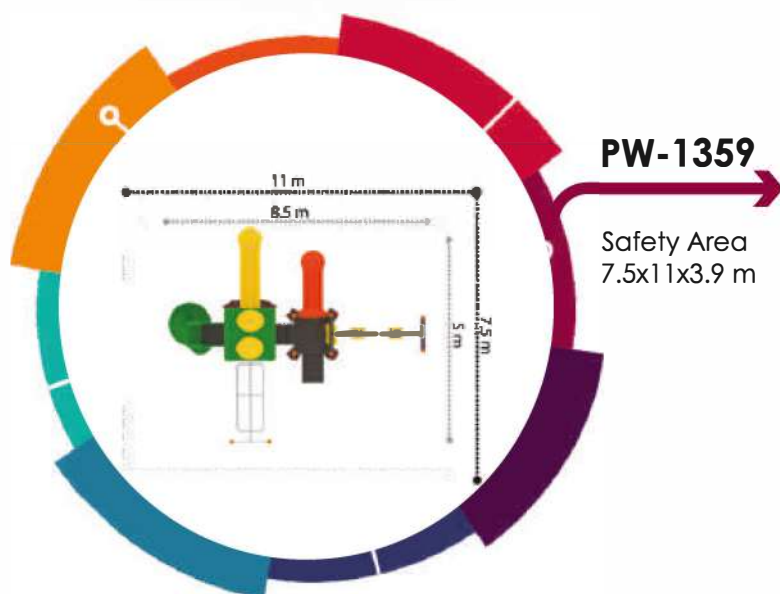
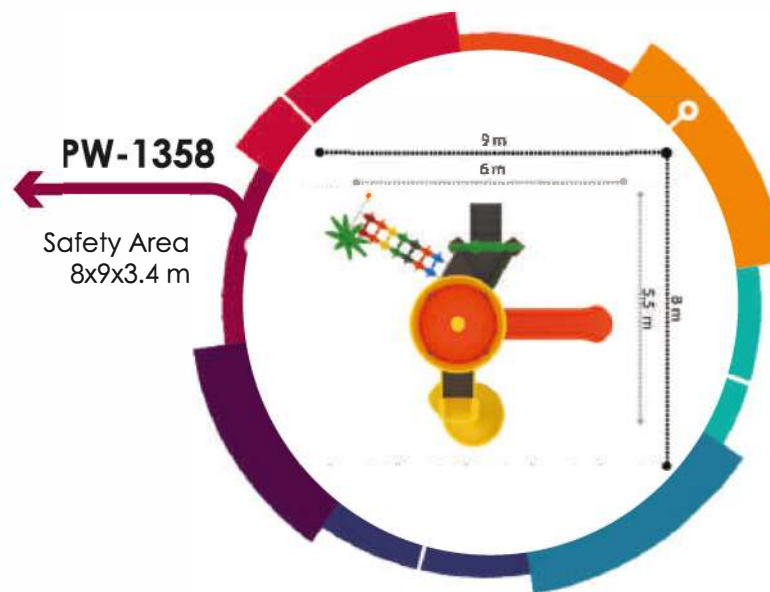

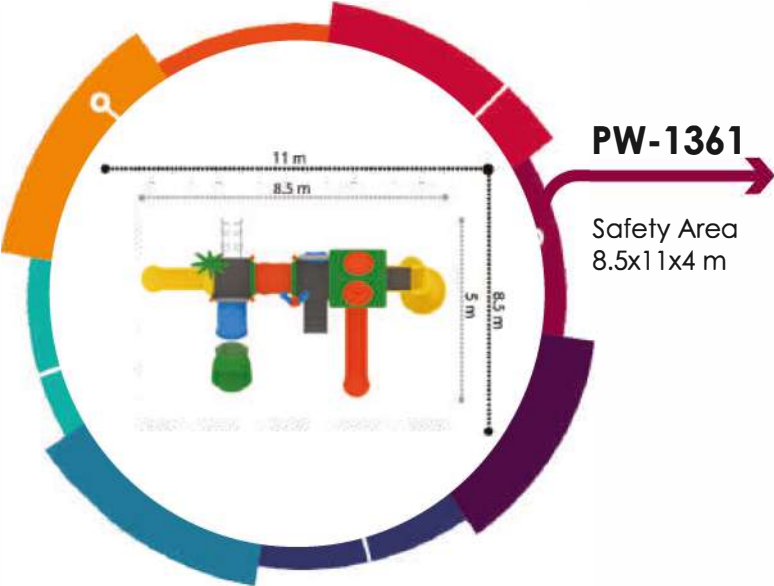
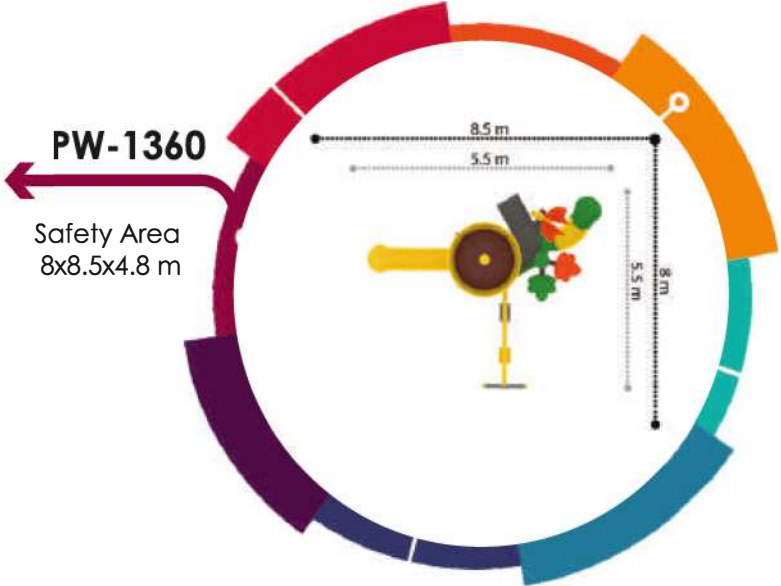





MONTE EXPRESS

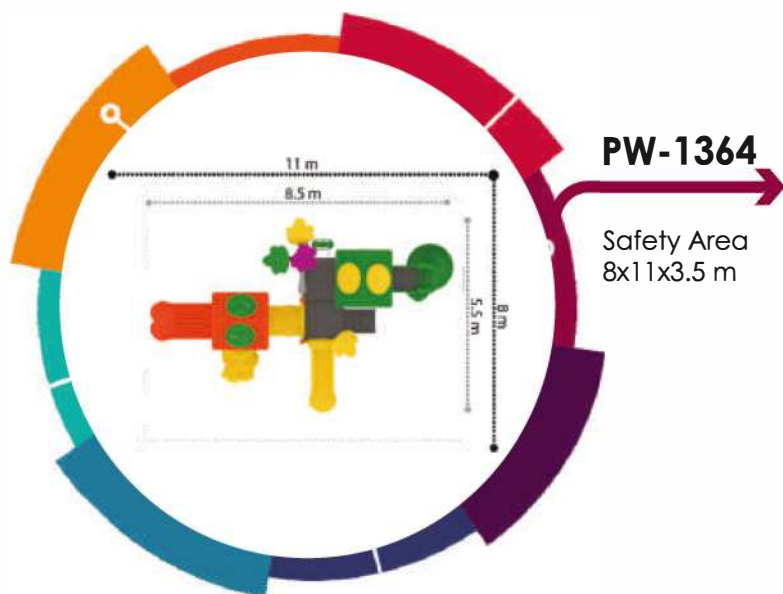
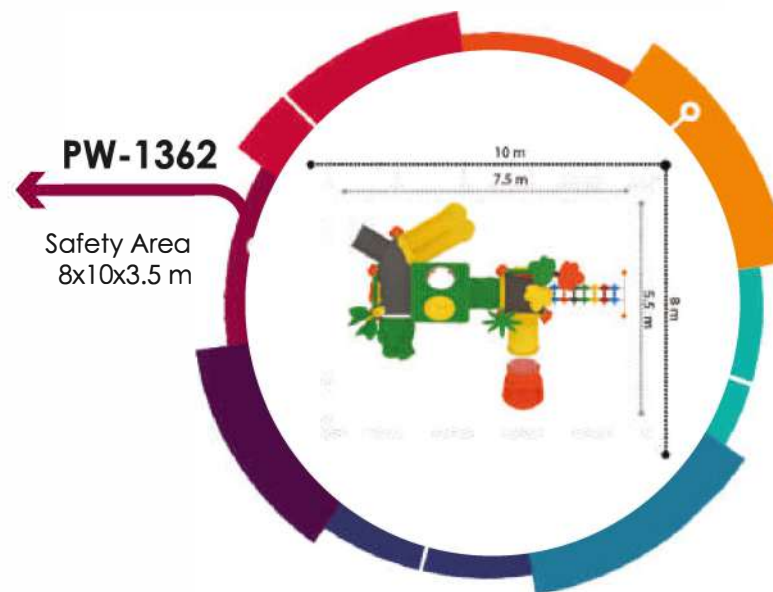

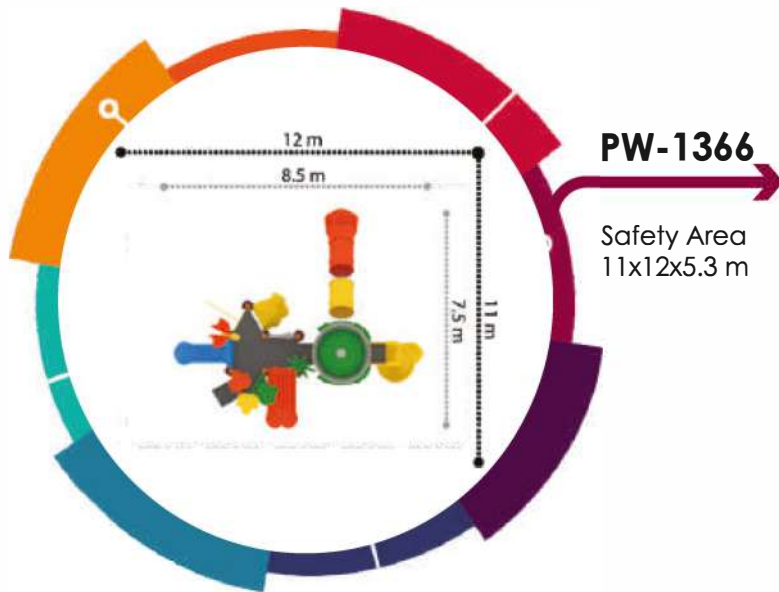
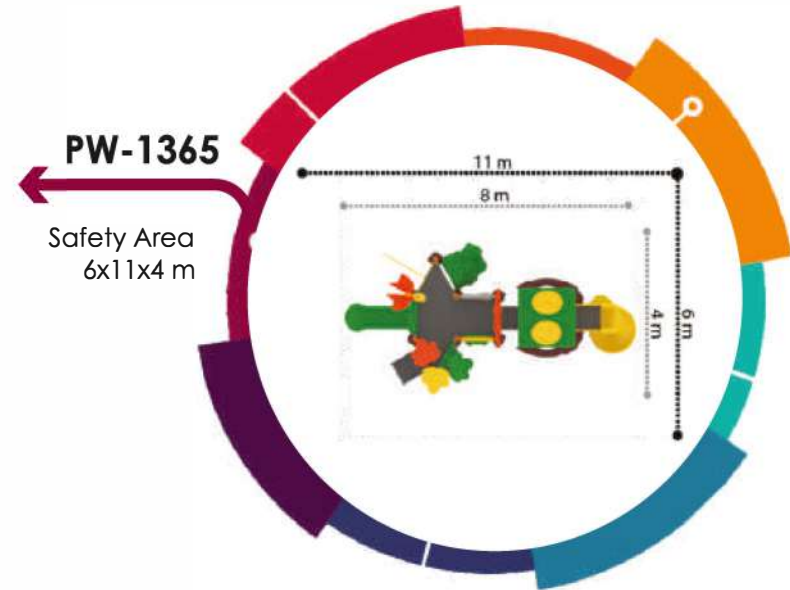





MONTE EXPRESS

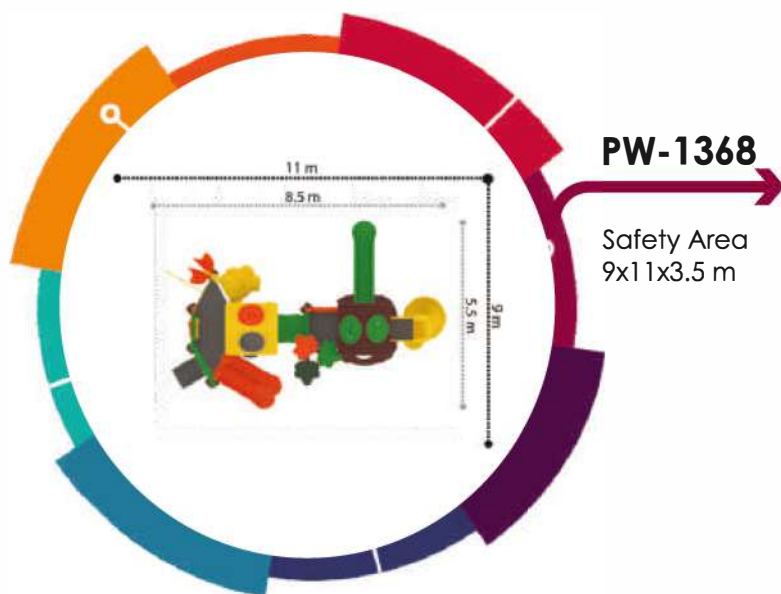
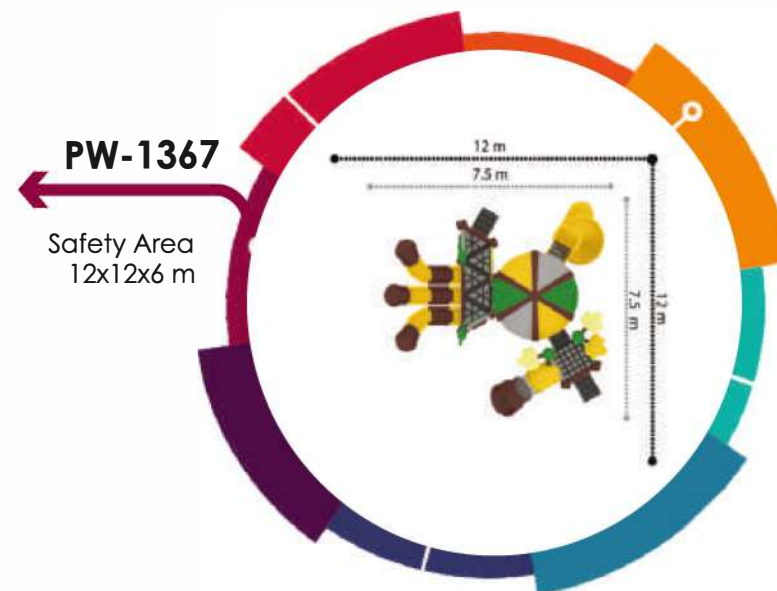





**PW-1369**

Safety Area  
12x13x5.5 m

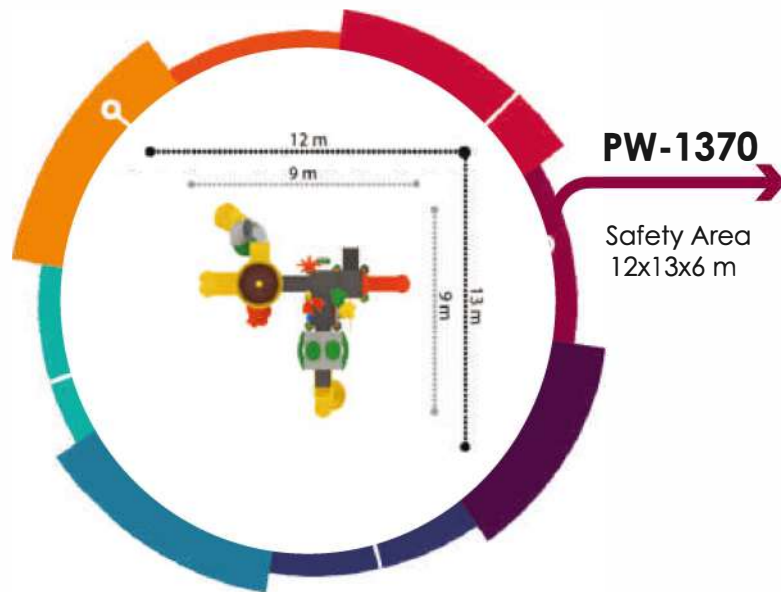
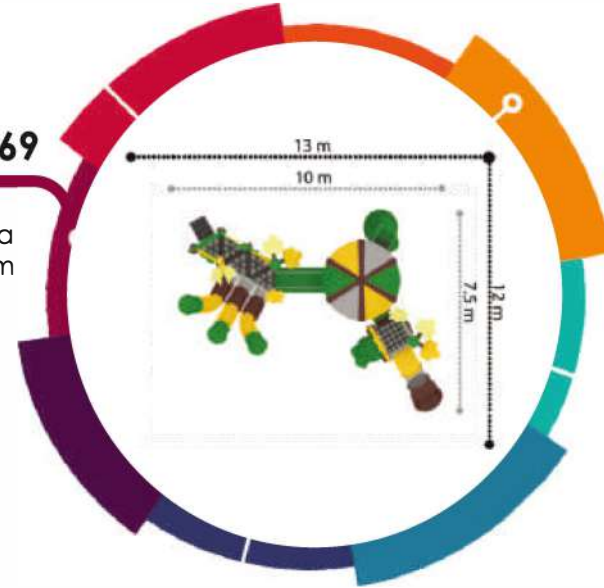

**PW-1370**

Safety Area  
12x13x6 m





MONTE EXPRESS

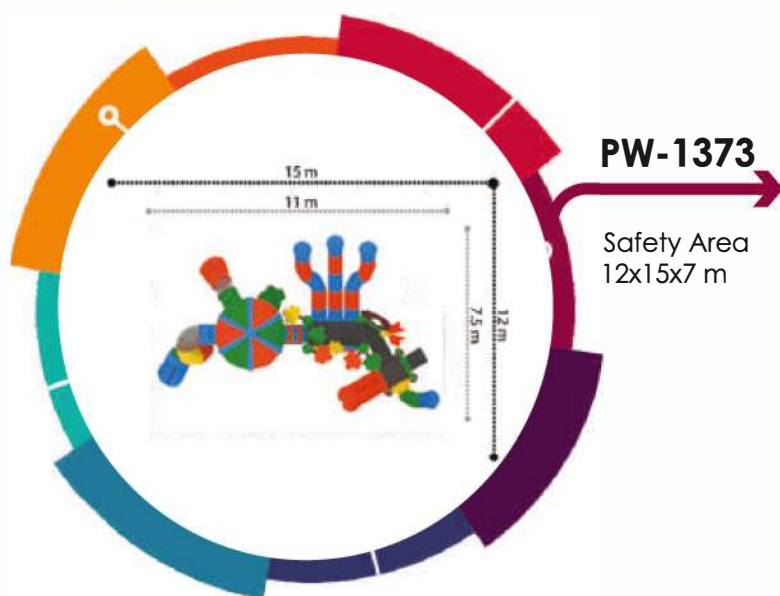
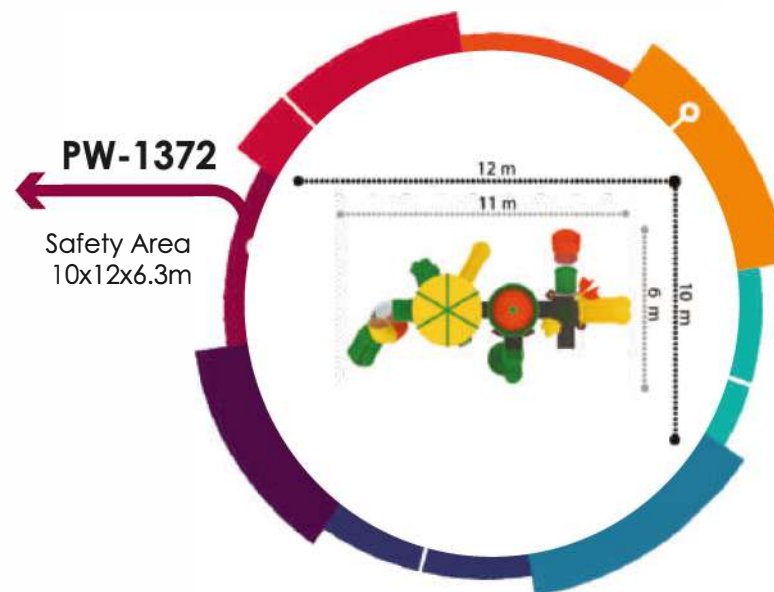



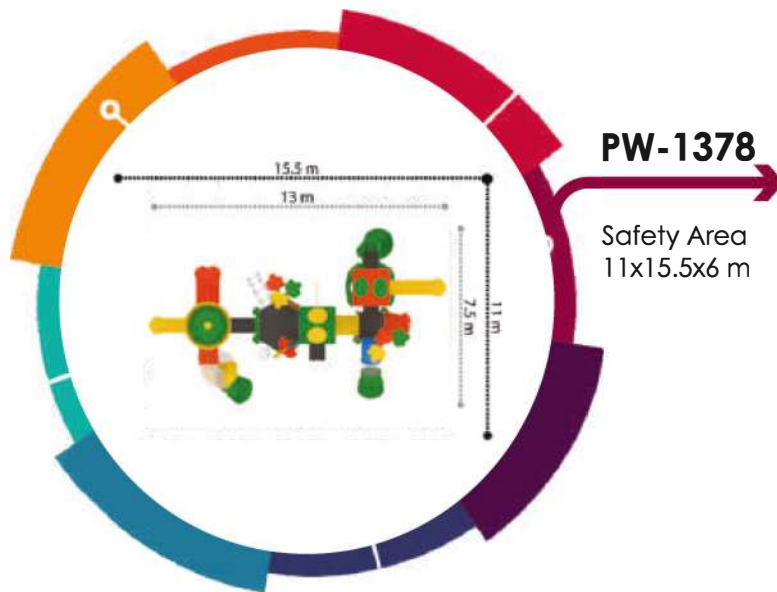
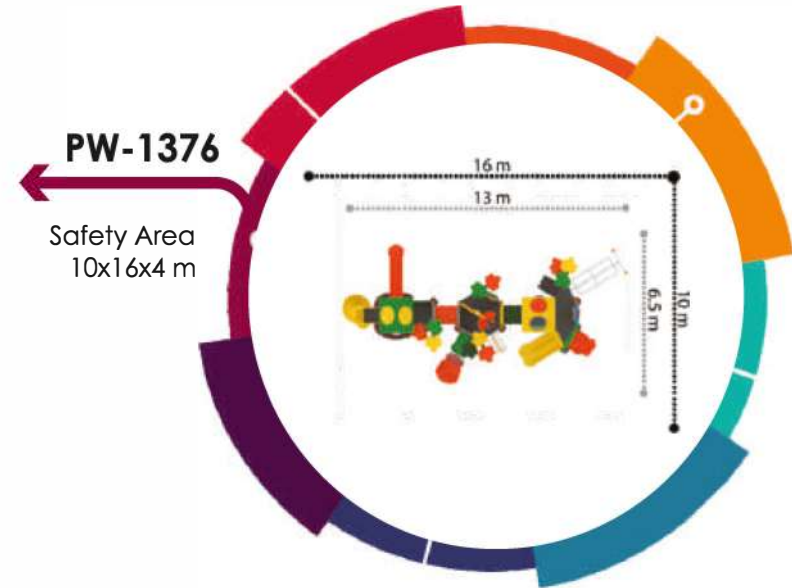





MONTE EXPRESS

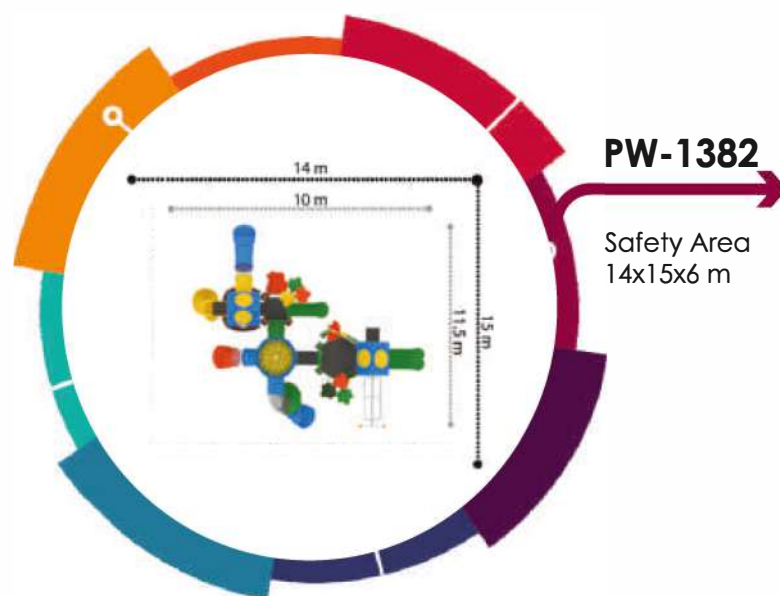
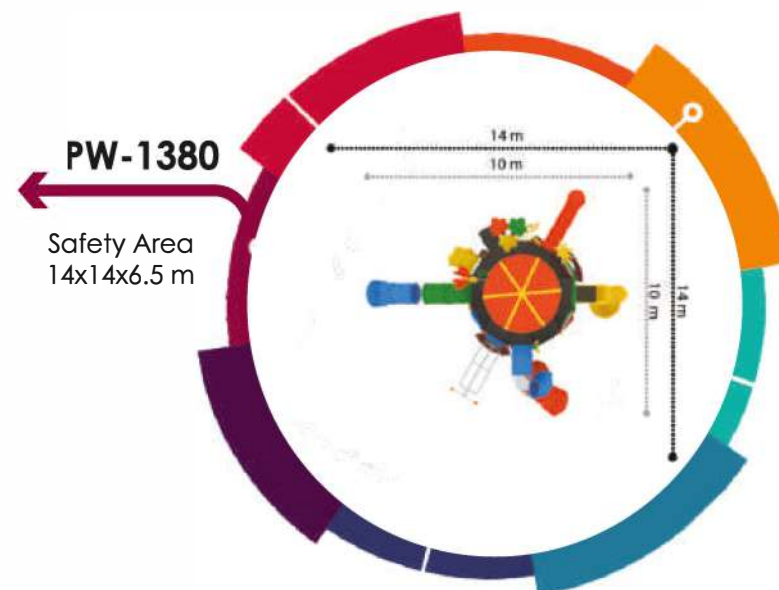

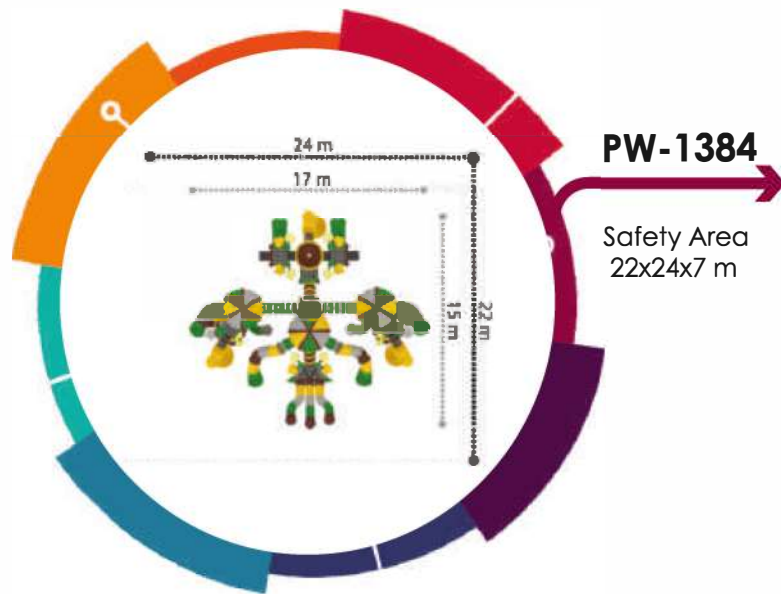
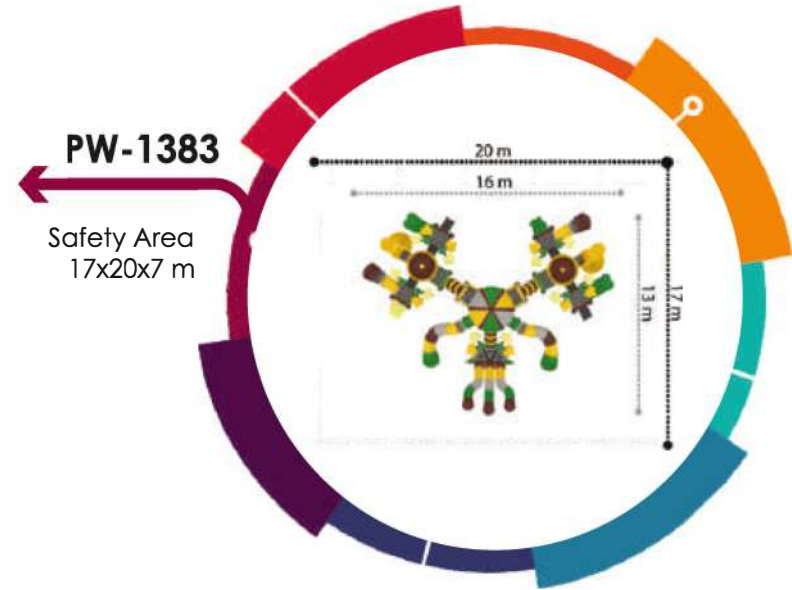





TRAIN SERIES



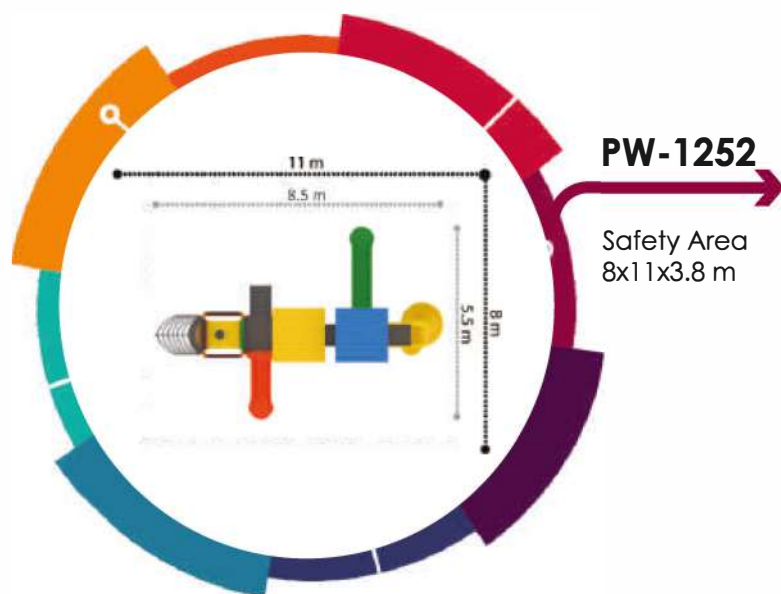
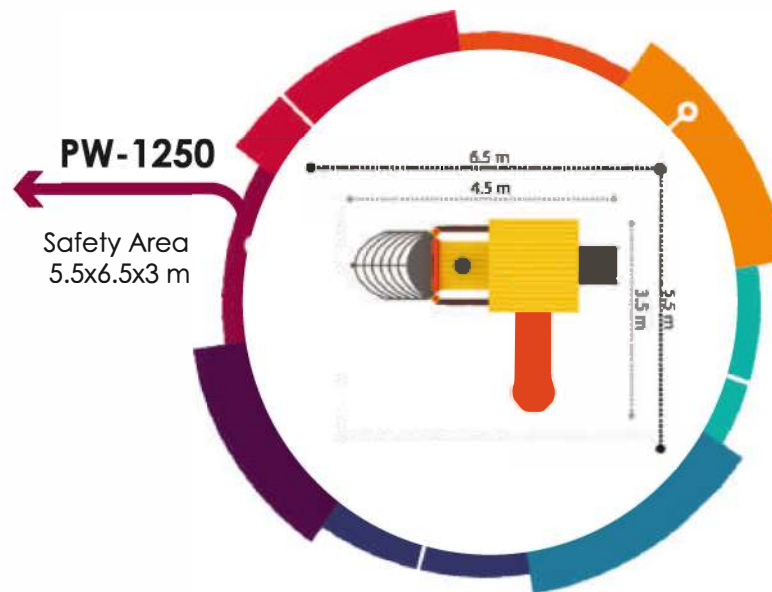



MONTE EXPRESS

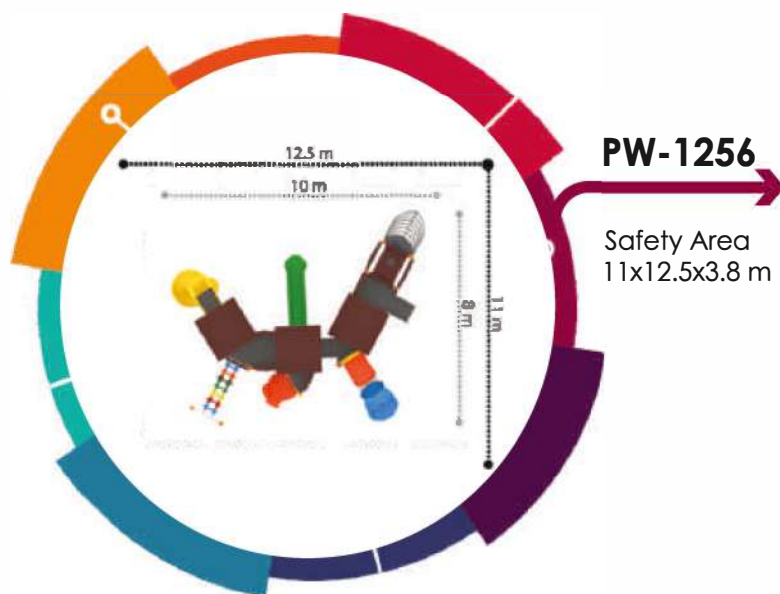
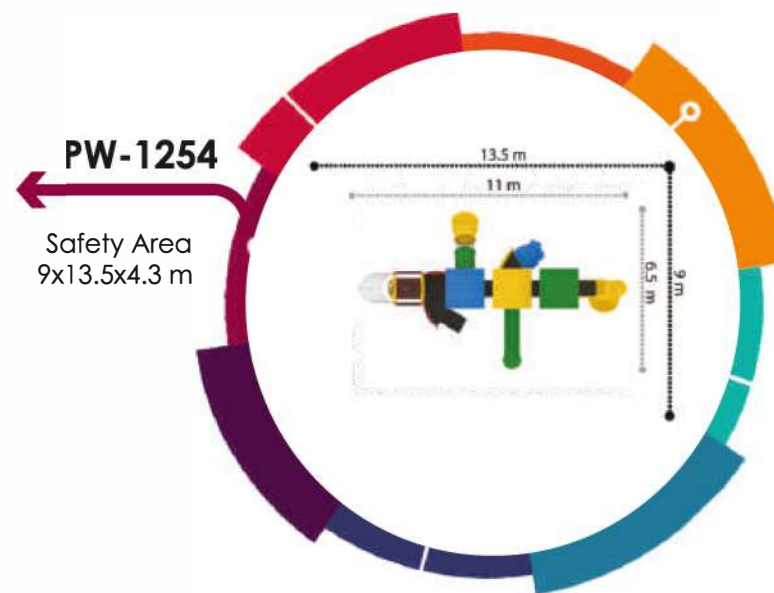

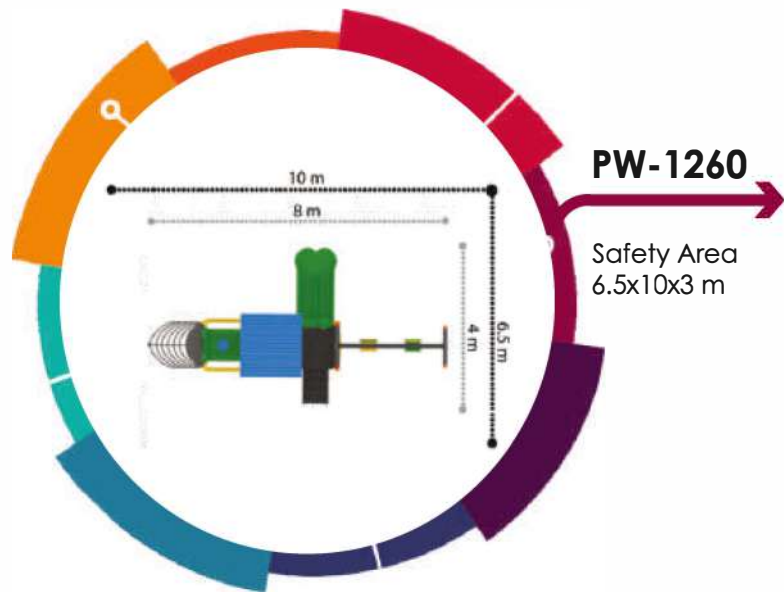
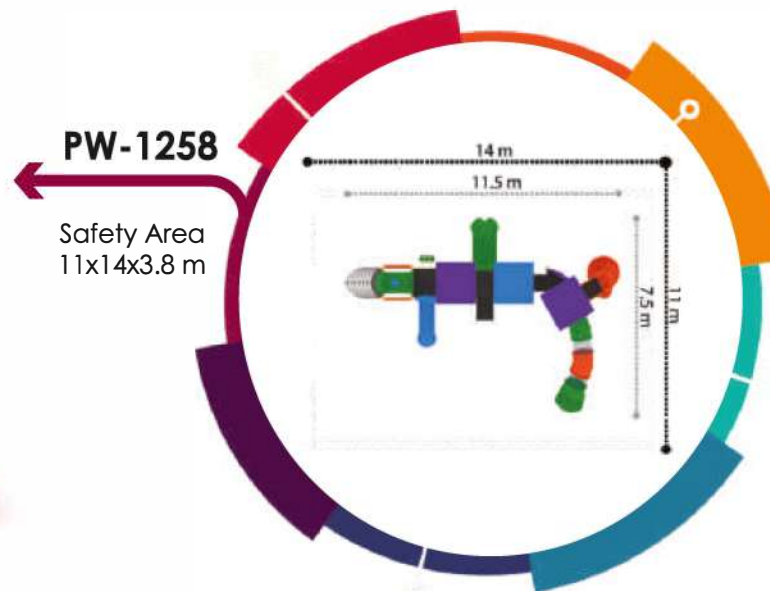





SHIP SERIES

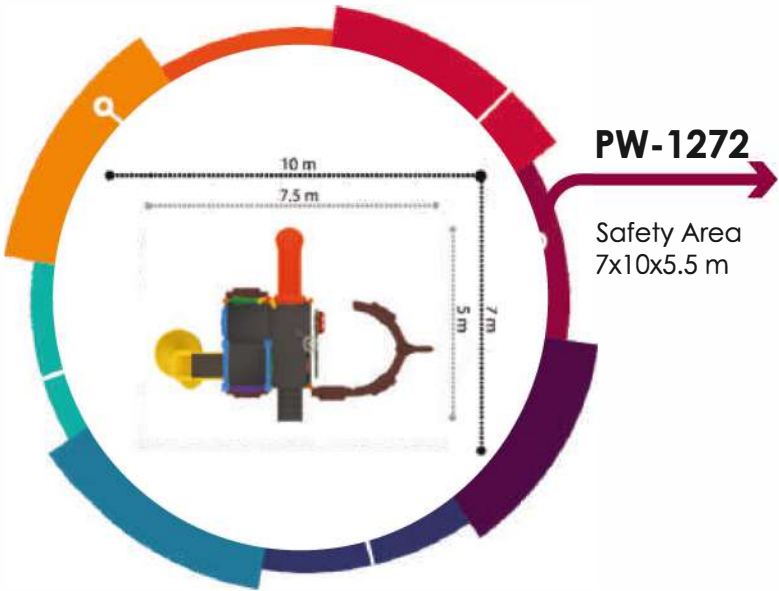
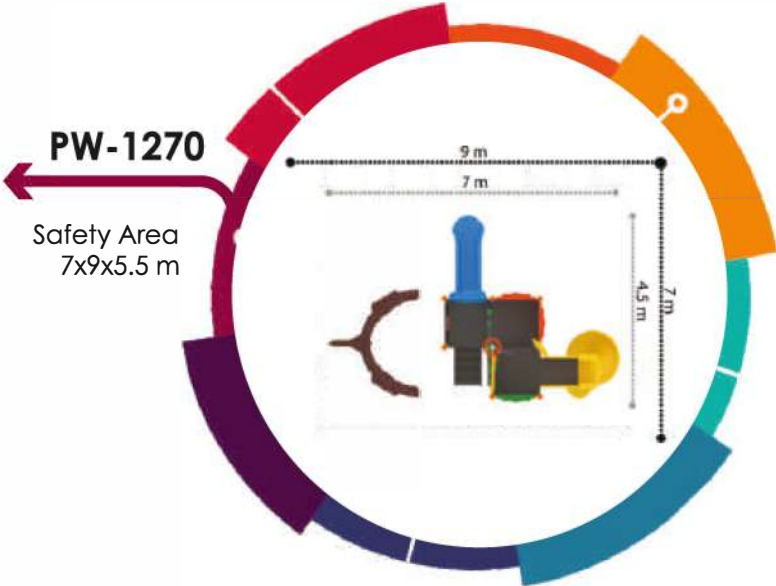



MONTE EXPRESS

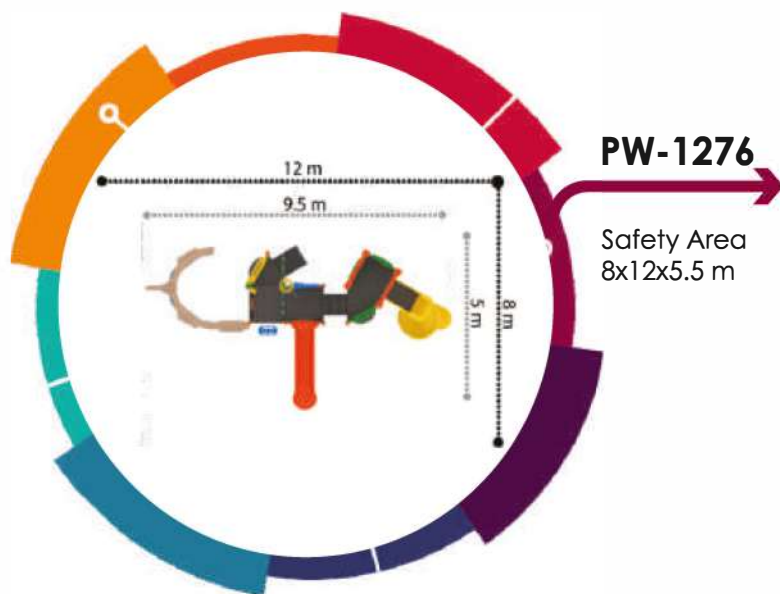
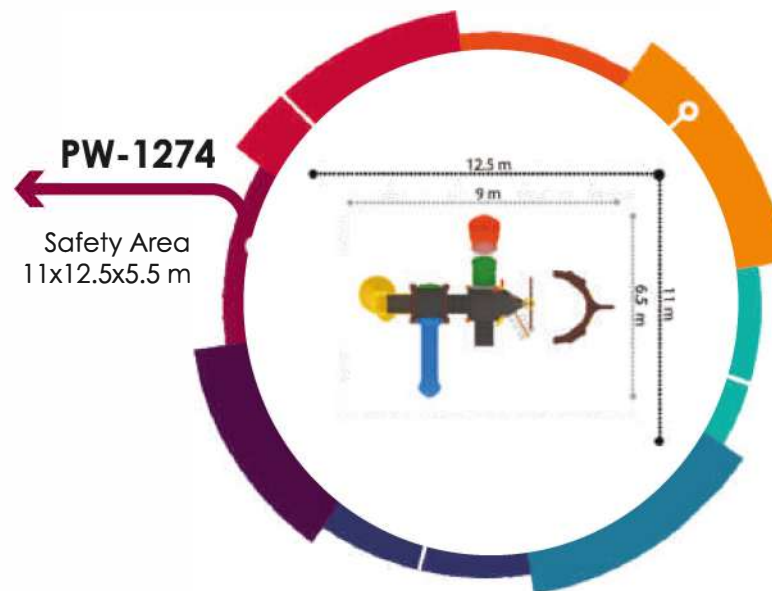



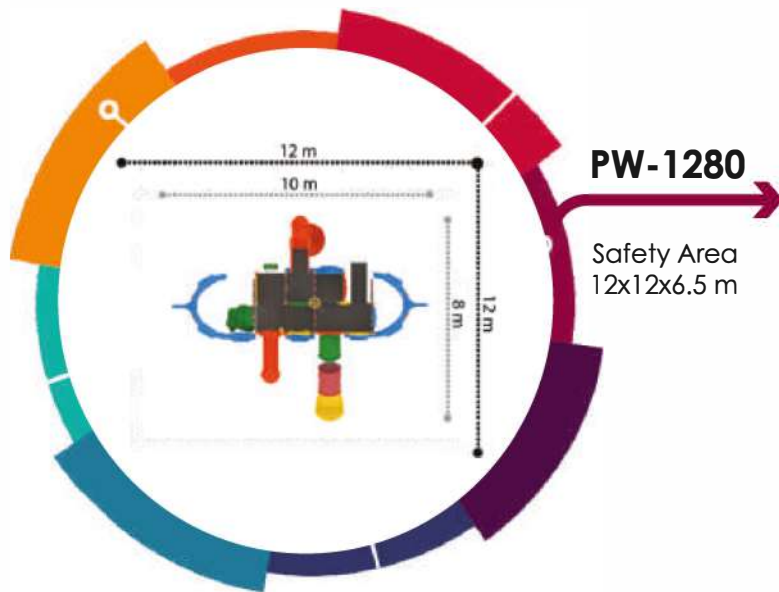
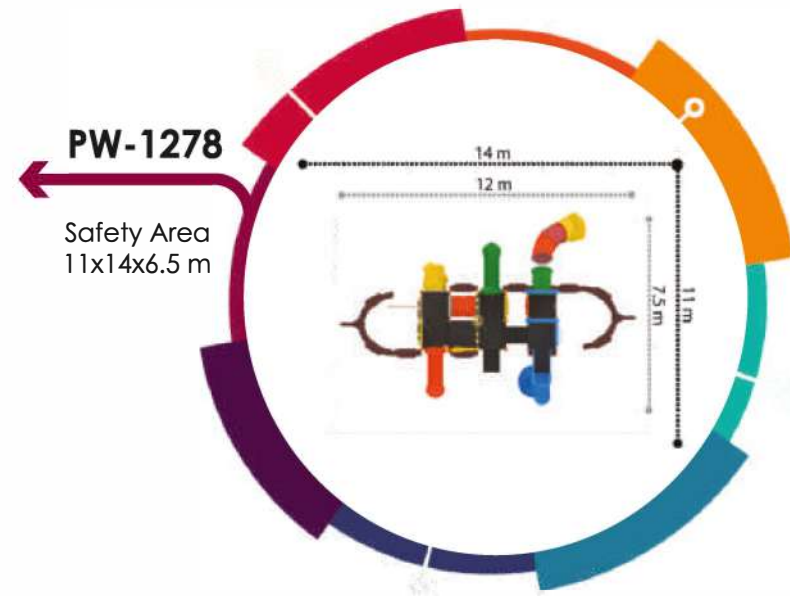



WOODEN SERIES

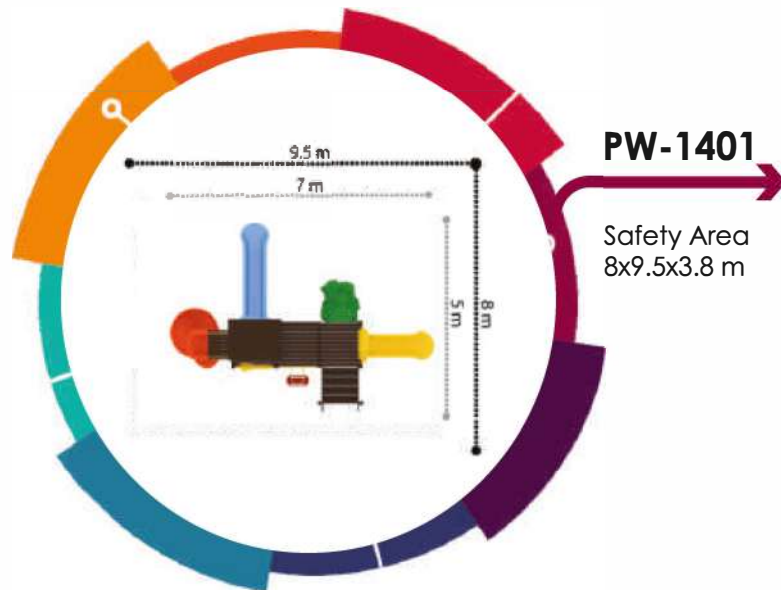
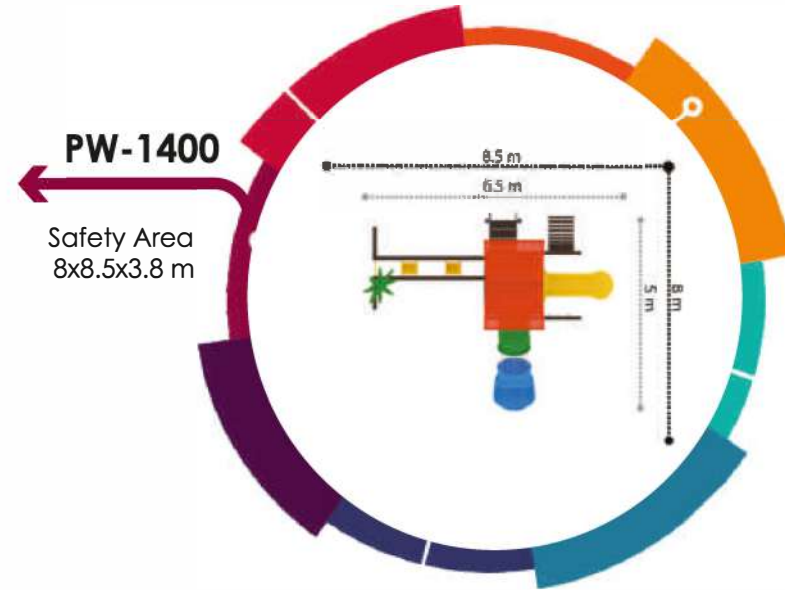





MONTE EXPRESS

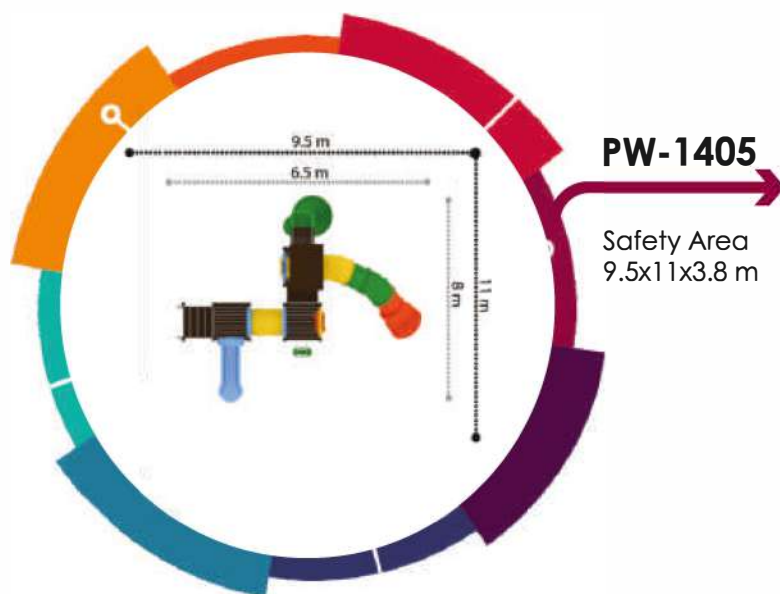
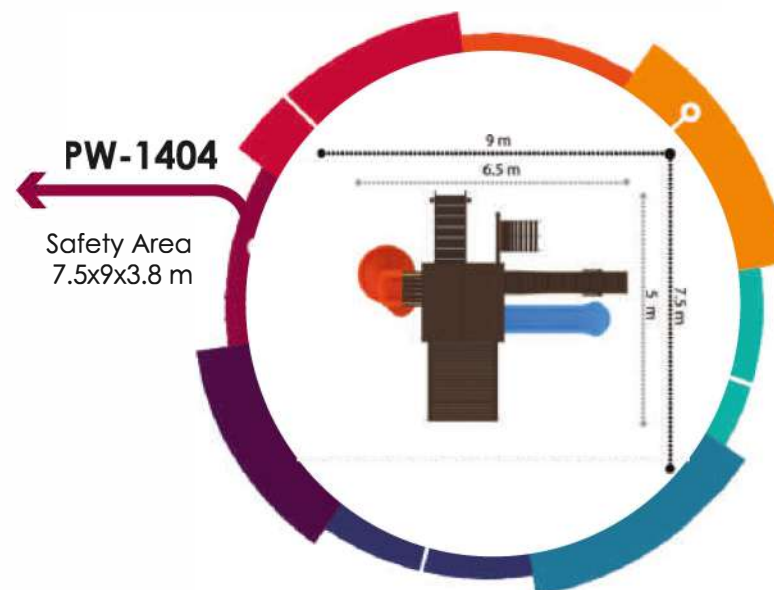

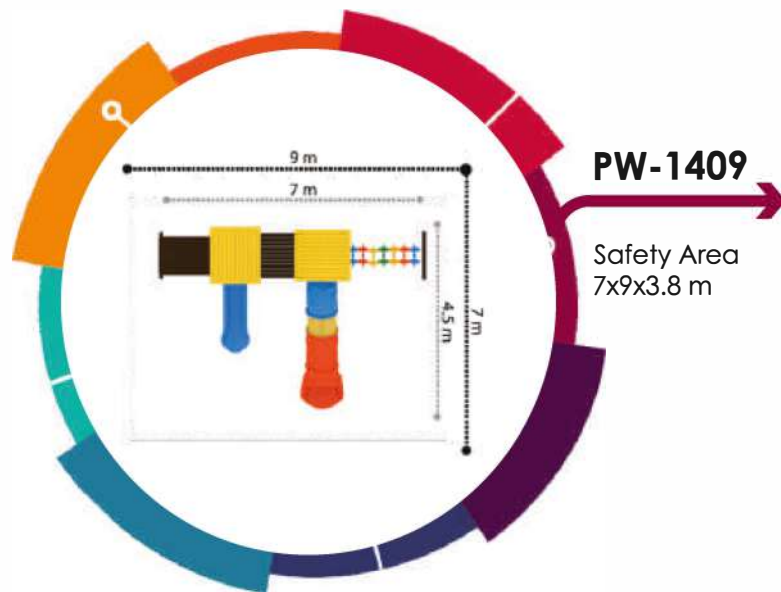
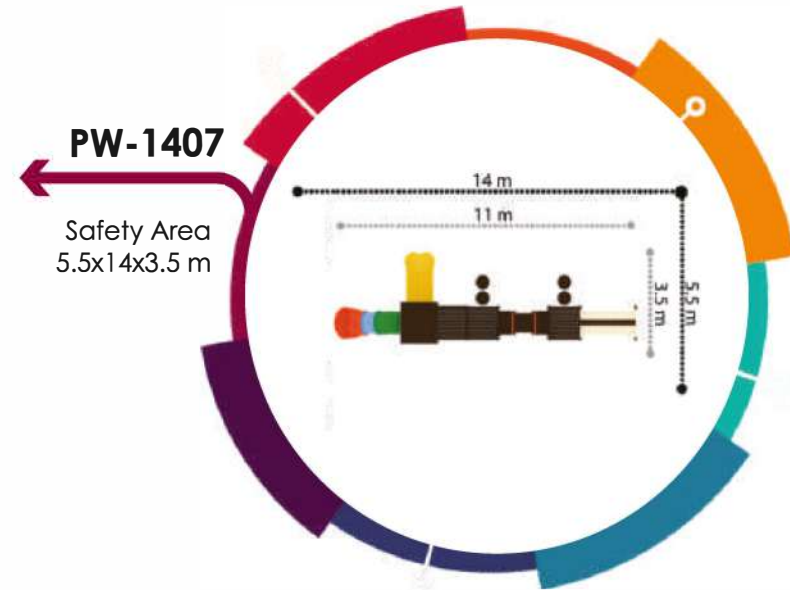

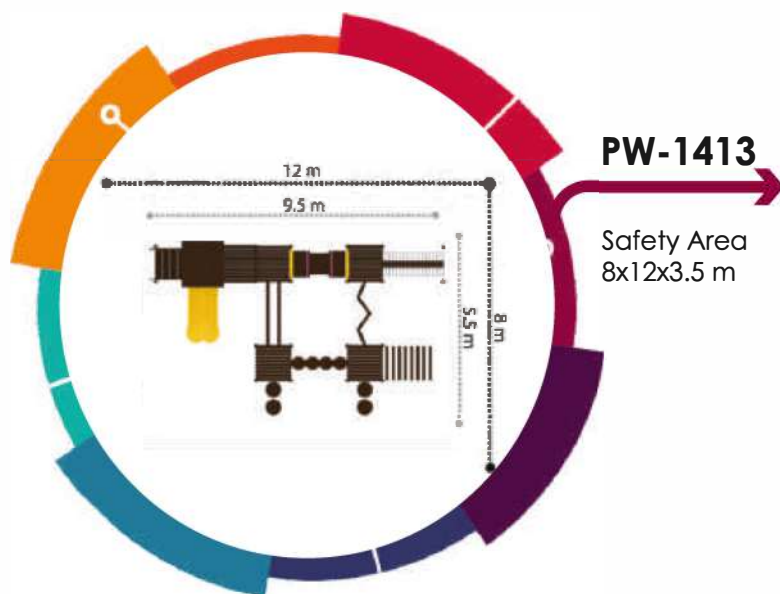
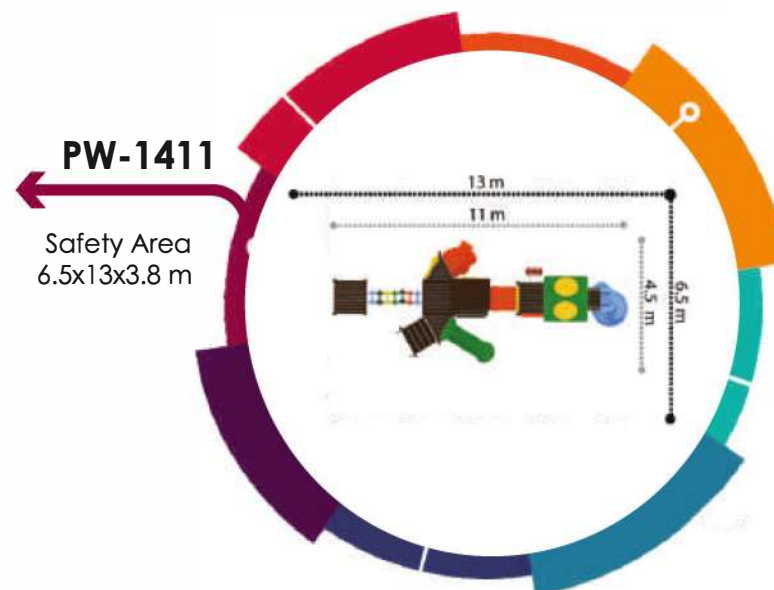



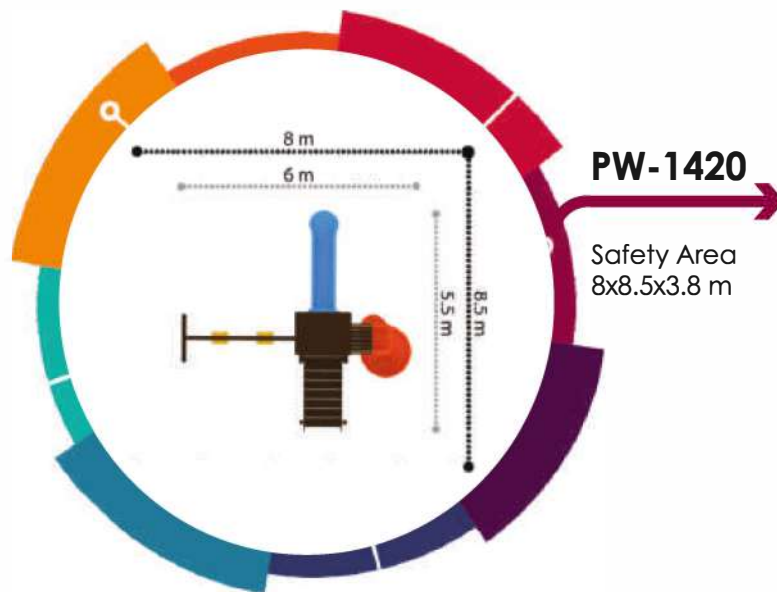
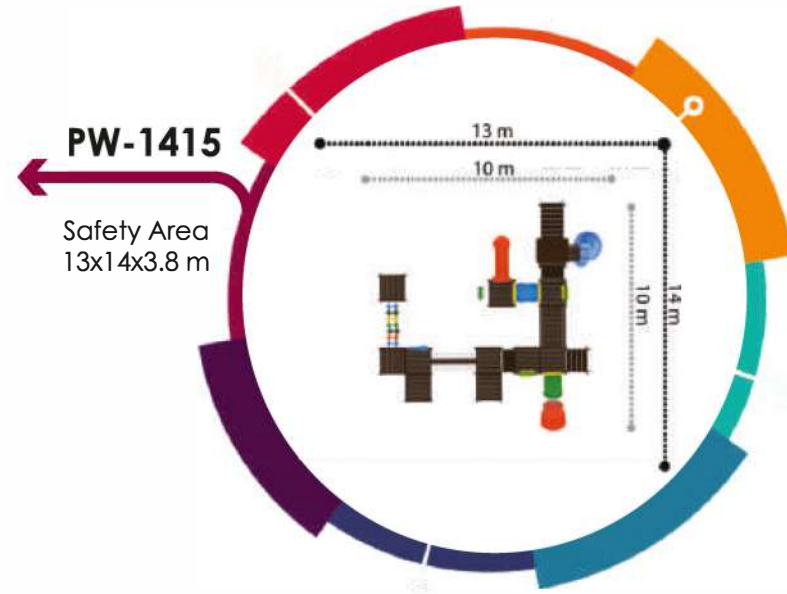



DISABLED SERIES

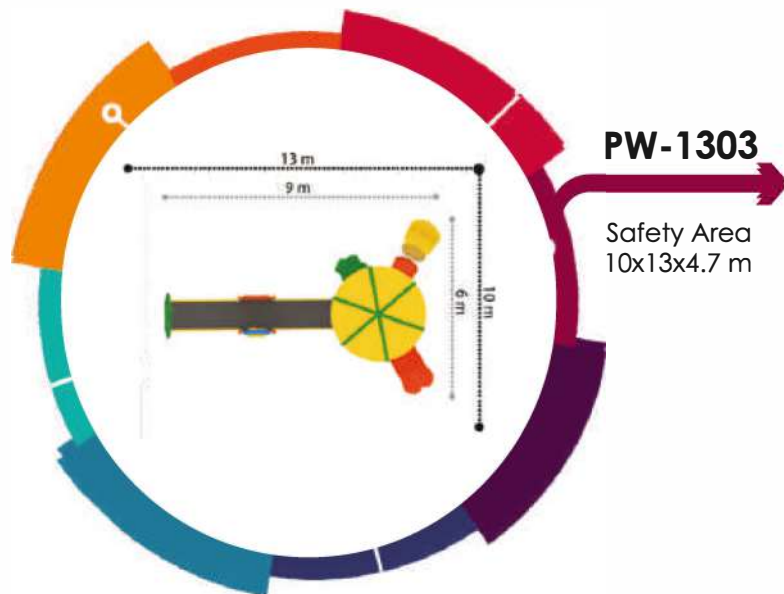
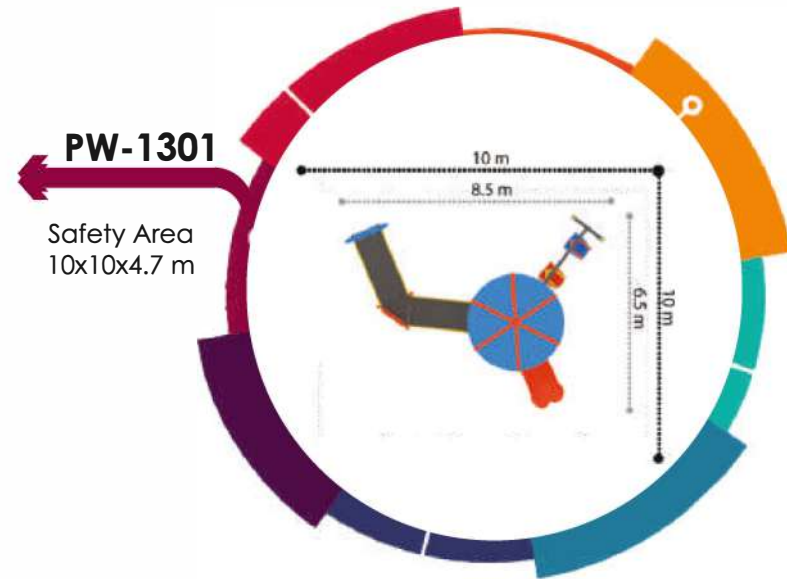





MONTE EXPRESS

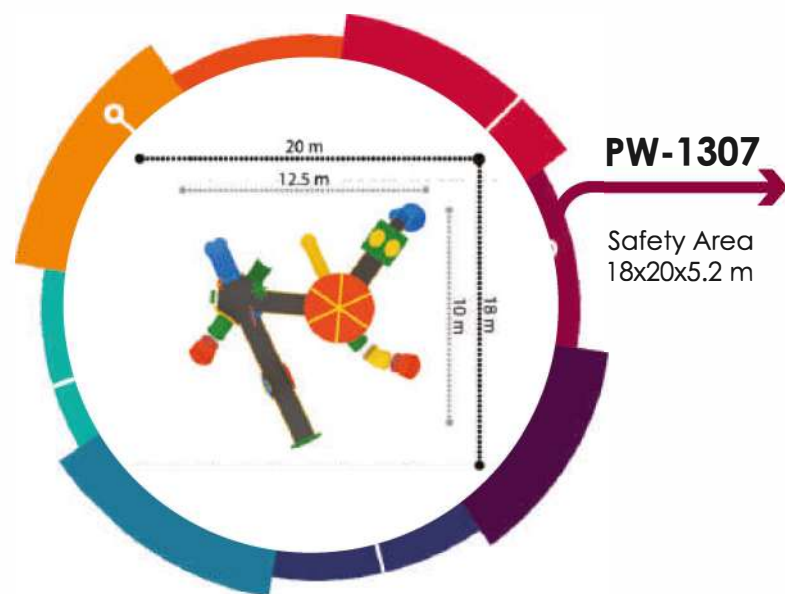
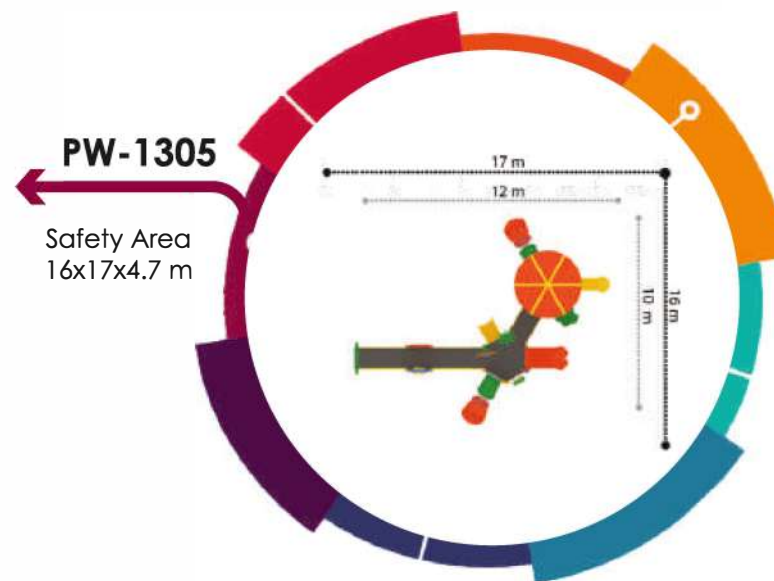

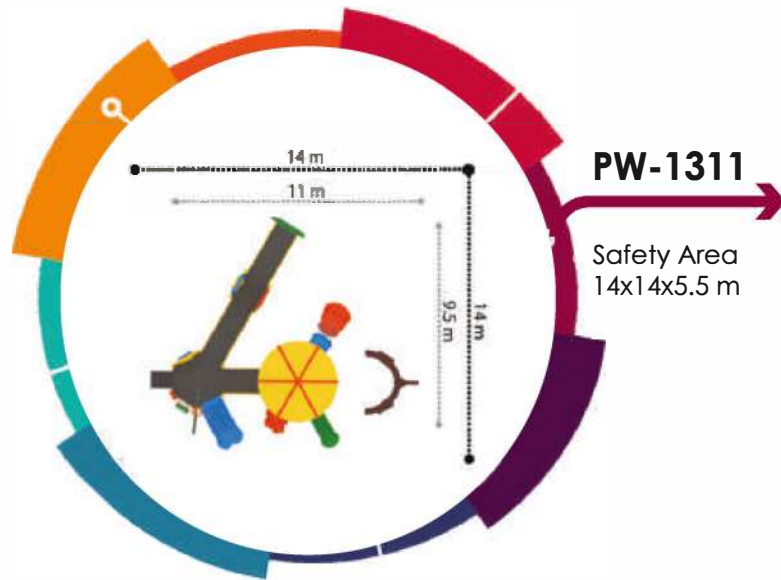
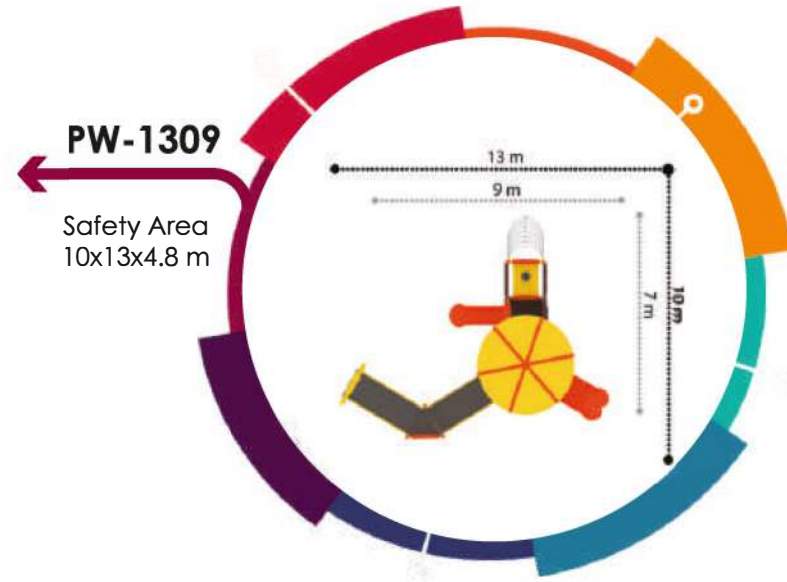



THEME SERIES



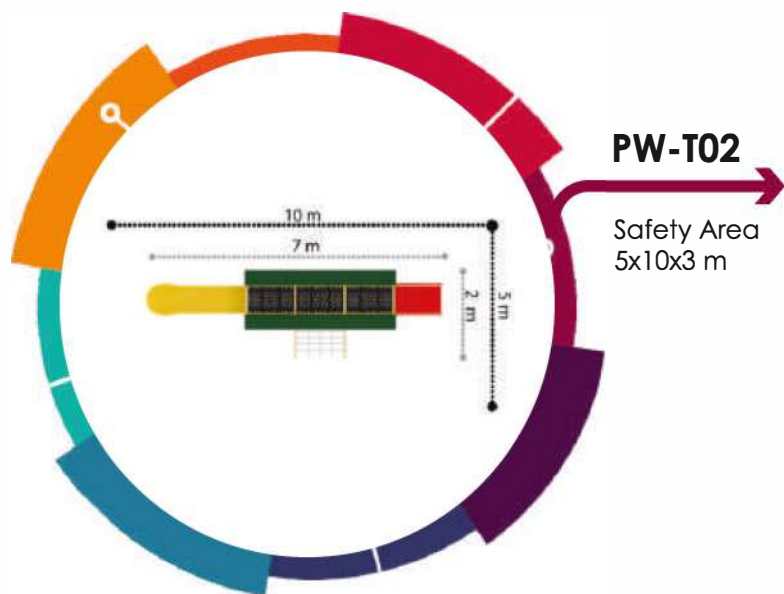
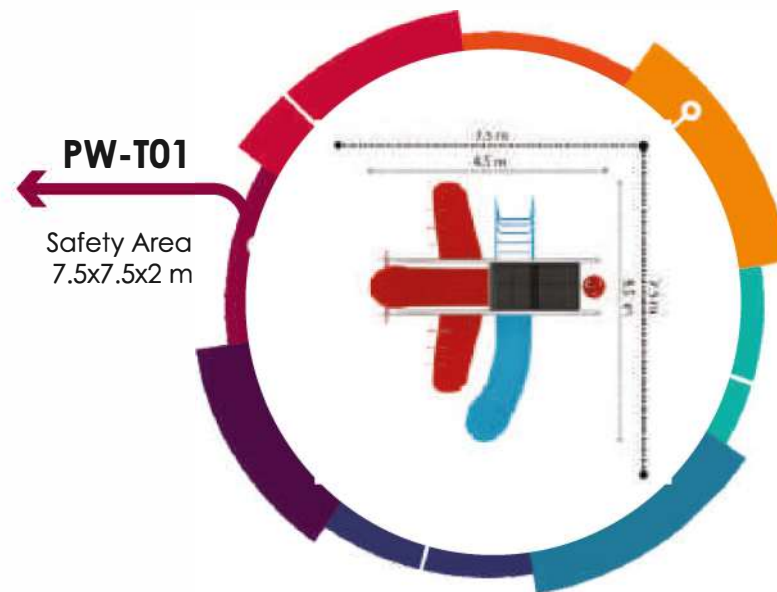



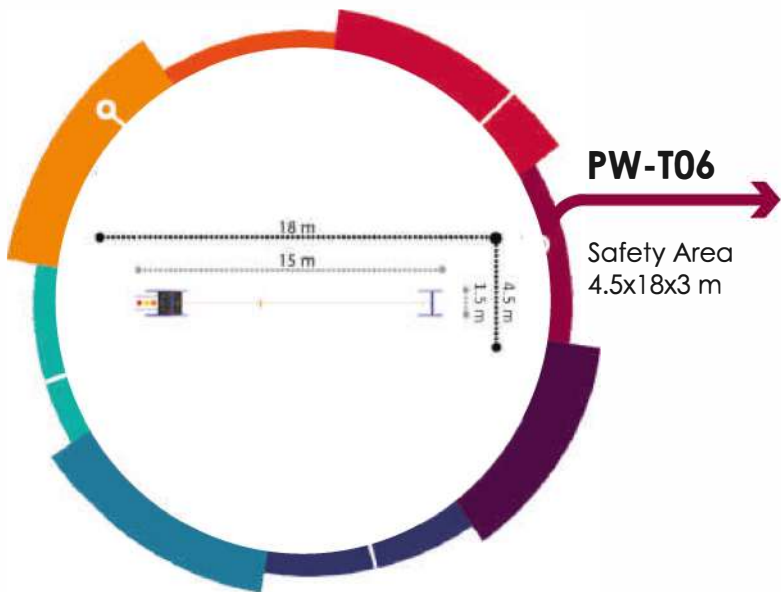
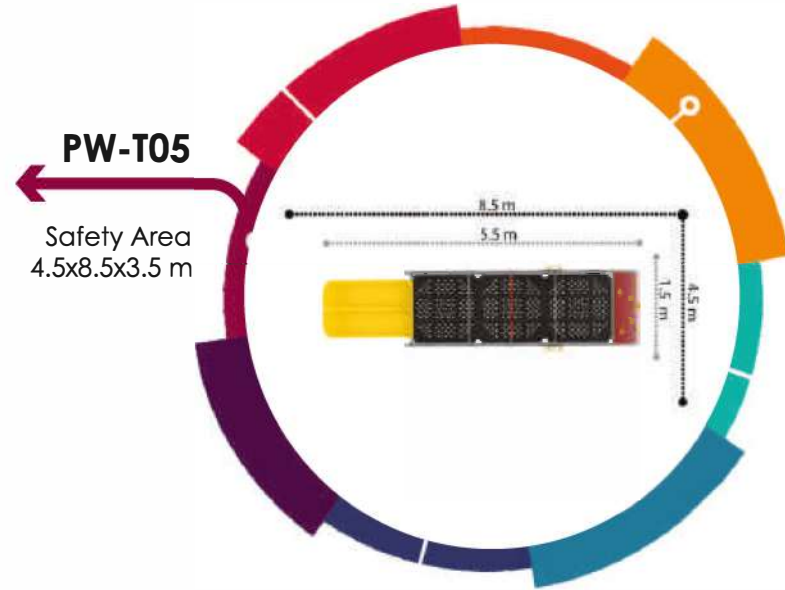



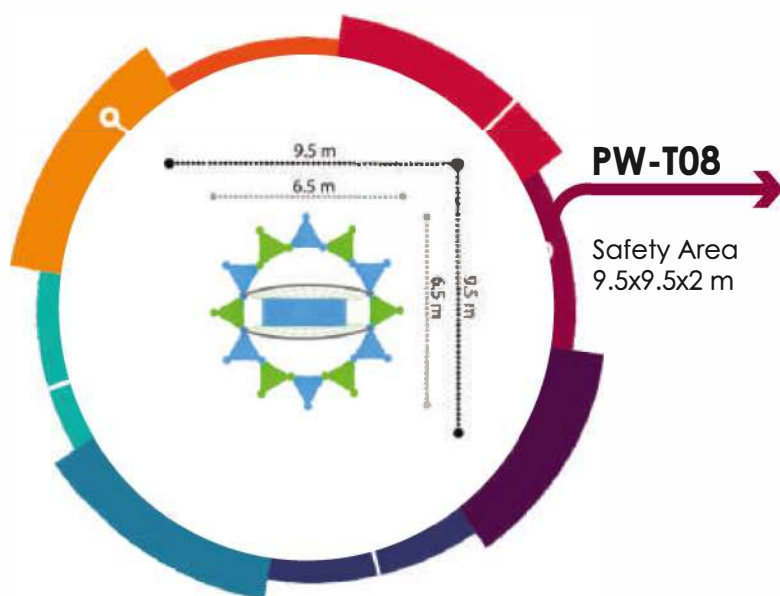
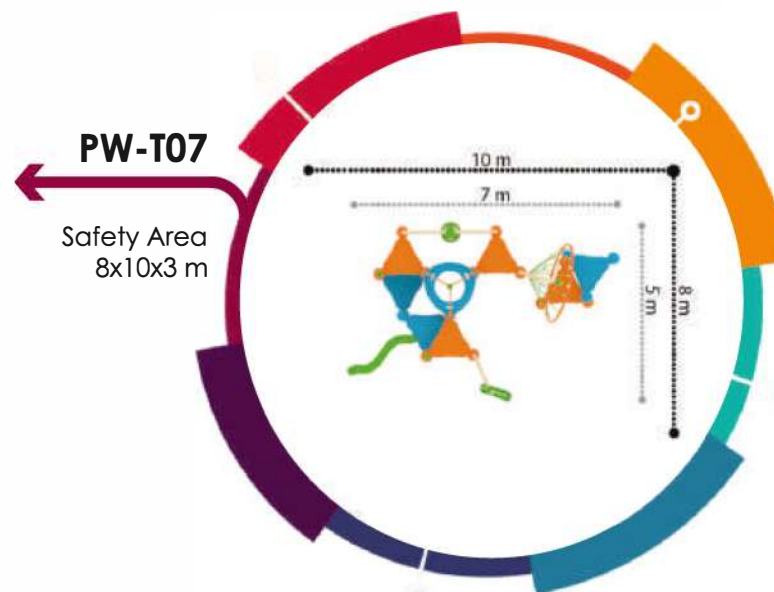

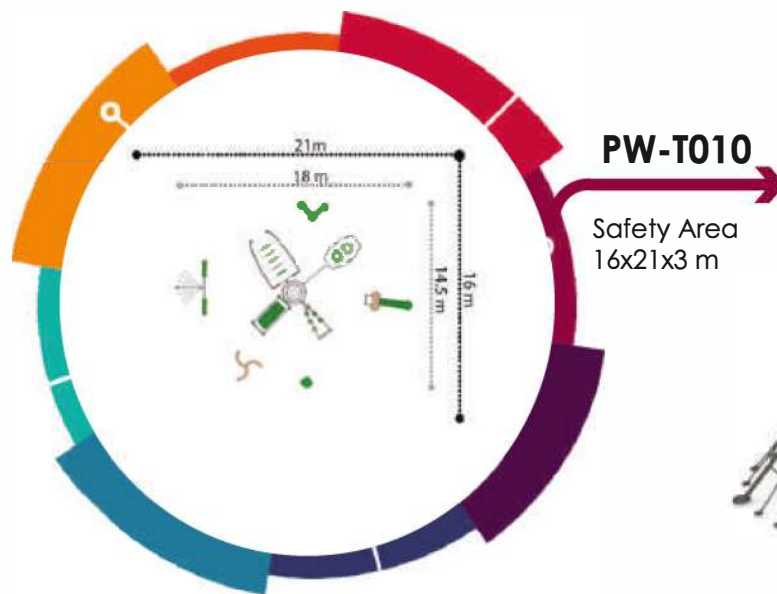
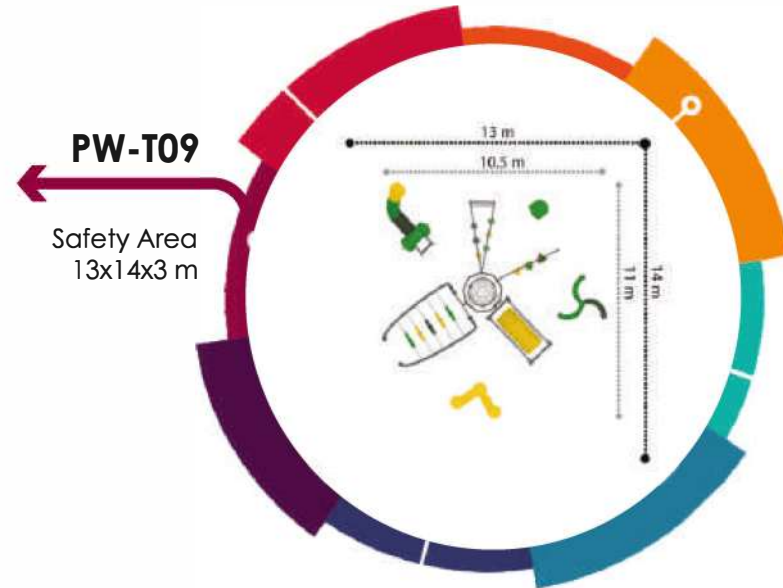



PLAY EQUIPMENTS





**PW-1500**

Fitting Area  
300 x 200 cm



**PW-1504**

Fitting Area  
300 x 250 cm



**PW-1507**

Fitting Area  
300 x 150 cm



**PW-1501**

Fitting Area  
300 x 250 cm



**PW-1505**

Fitting Area  
250 x 150 cm



**PW-1506**

Fitting Area  
300 x 150 cm



**PW-1509**

Fitting Area  
550 x 550 cm



**PW-1510**

Fitting Area  
250 x 150 cm



**PW-3203**

Fitting Area  
350 x 250 cm



**PW-1517**

Fitting Area  
300 x 200 cm



**PW-1518**

Fitting Area  
300 x 250 cm



**PW-1519**

Fitting Area  
300 x 150 cm



**PW-3201**

Fitting Area  
300 x 200 cm



**PW-3202**

Fitting Area  
300 x 200 cm



**PW-3204**

Fitting Area  
300 x 200 cm



**PW-3205**

Fitting Area  
300 x 200 cm



**PW-3206**

Fitting Area  
300 x 200 cm



**PW-3207**

Fitting Area  
300 x 200 cm





**PW-1502**

Fitting Area  
250 x 150 cm



**PW-1503**

Fitting Area  
250 x 150 cm



**PW-3211**

Fitting Area  
250 x 150 cm



**PW-1513**

Fitting Area  
250 x 150 cm



**PW-1514**

Fitting Area  
150 x 150 cm



**PW-1512**

Fitting Area  
150 x 150 cm





**PW-1524**

Fitting Area  
150 x 50 cm



**PW-1530**

Fitting Area  
150 x 50 cm



**PW-1532**

Fitting Area  
150 x 50 cm



**PW-1534**

Fitting Area  
150 x 50 cm



**PW-1527**

Fitting Area  
300 x 50 cm



**PW-1528**

Fitting Area  
200 x 200 cm



**PW-1525**

Fitting Area  
350 x 50 cm



**PW-3301**

Fitting Area  
50 x 70 cm



**PW-3302**

Fitting Area  
50 x 70 cm



**PW-3303**

Fitting Area  
50 x 70 cm



**PW-3304**

Fitting Area  
50 x 70 cm



**PW-3305**

Fitting Area  
100 x 20 cm





**PW-3306**

Fitting Area  
50 x 70 cm



**PW-3311**

Fitting Area  
80 x 100 cm



**PW-3312**

Fitting Area  
100 x 150 cm



**PW-3307**

Fitting Area  
130 x 30 cm

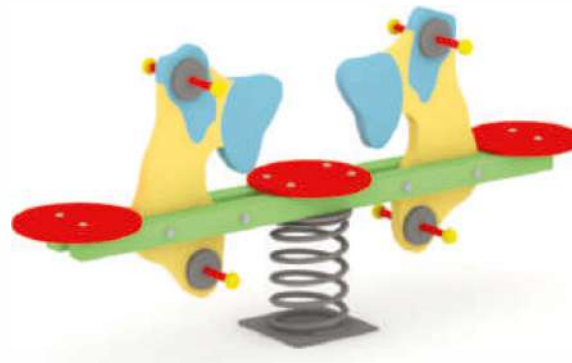

**PW-3308**

Fitting Area  
130 x 30 cm



**PW-3309**

Fitting Area  
130 x 30 cm





**PW-3314**

Fitting Area  
40 x 250 cm

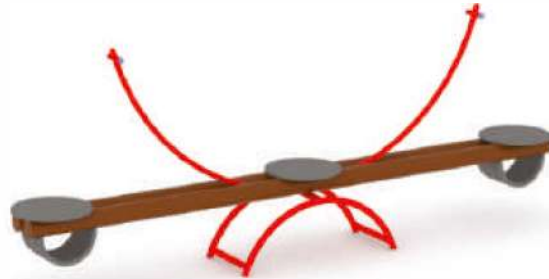

**PW-3315**

Fitting Area  
30 x 250 cm



**PW-3316**

Fitting Area  
30 x 250 cm



**PW-1522**

Fitting Area  
50 x 300 cm



**PW-1520**

Fitting Area  
50 x 300 cm



**PW-1523**

Fitting Area  
50 x 300 cm





**PW-1516**

Fitting Area  
100 x 300 cm



**PW-1539**

Fitting Area  
220 x 220 cm



**PW-1540**

Fitting Area  
215 x 215 cm

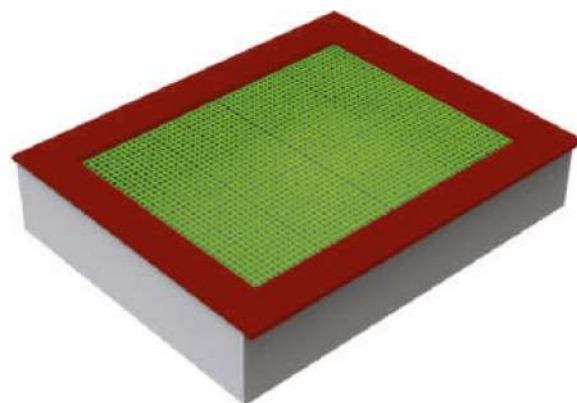

**PW-1541**

(Rectangle Trampoline)

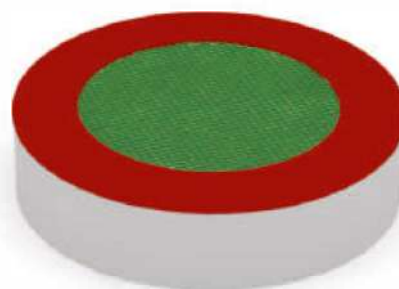

**PW-1542**

(Circle Trampoline)



**PW-1543**

(Moduler Trampoline)



**PW-1544**

Fitting Area  
90x180x150 cm



**PW-1545**

Fitting Area  
90x180x160 cm

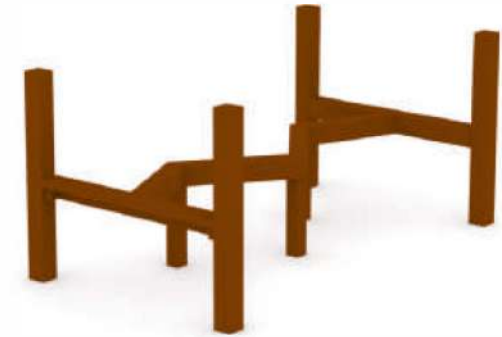

**PW-1546**

Fitting Area  
90x120x50 cm



**PW-1547**

Fitting Area  
90x120x100 cm

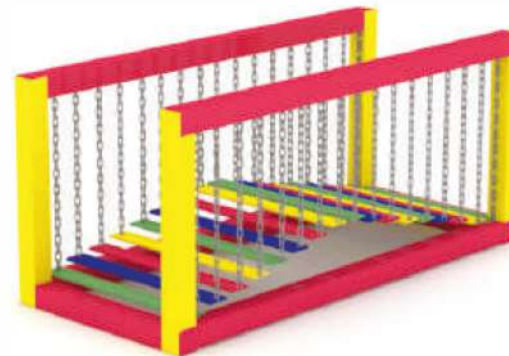

**PW-3321**

Fitting Area  
100x230x100 cm



**PW-3322**

Fitting Area  
100x300x100 cm







**PW-3350**

Fitting Area  
100x200x170 cm



**PW-3351**

Fitting Area  
150x150x200 cm



**PW-3352**

Fitting Area  
100x200x300 cm



**PW-3353**

Fitting Area  
100x200x170 cm



**PW-4023**

Fitting Area  
100x120x57 cm



**PW-4024**

Fitting Area  
100x120x57 cm



**PW-4010**

(Children's Bench With Plane Figure)

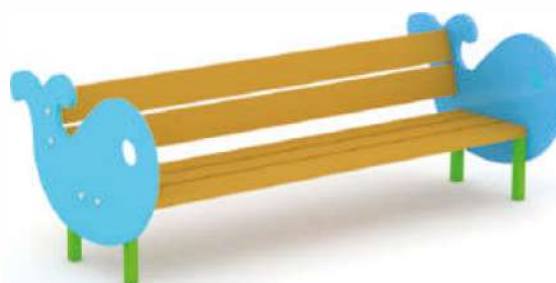

**PW-4011**

(Children's Bench With Whale Figure)

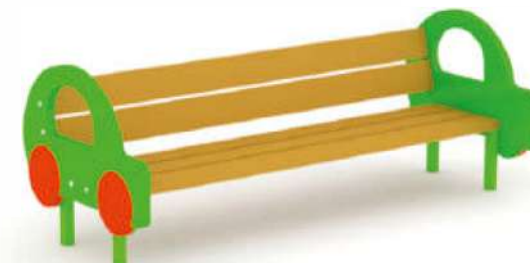

**PW-4012**

(Children's Bench With Car Figure)



**PW-4013**

(Children's Bench With Monkey Figure)



**PW-4016**

(Children's Bench With Butterfly Figure)



**PW-4018**

(Children's Bench With Fish Figure)

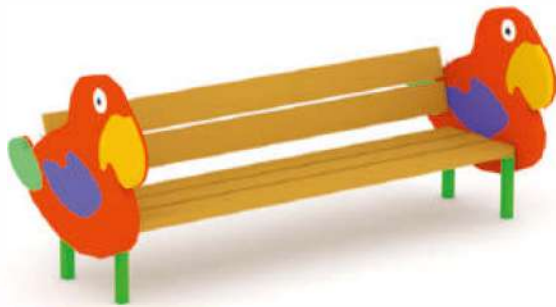

**PW-4015**

(Children's Bench With Parrot Figure)



**PW-4029**

(Children's Bench With Turtle Figure )



**PW-4019**

(Dustbin With Bird Figure)



**PW-4020**

(Dustbin With Panda Figure)



**PW-4021**

(Dustbin With Parrot Figure)



**PW-4022**

(Dustbin With Chick Figure)



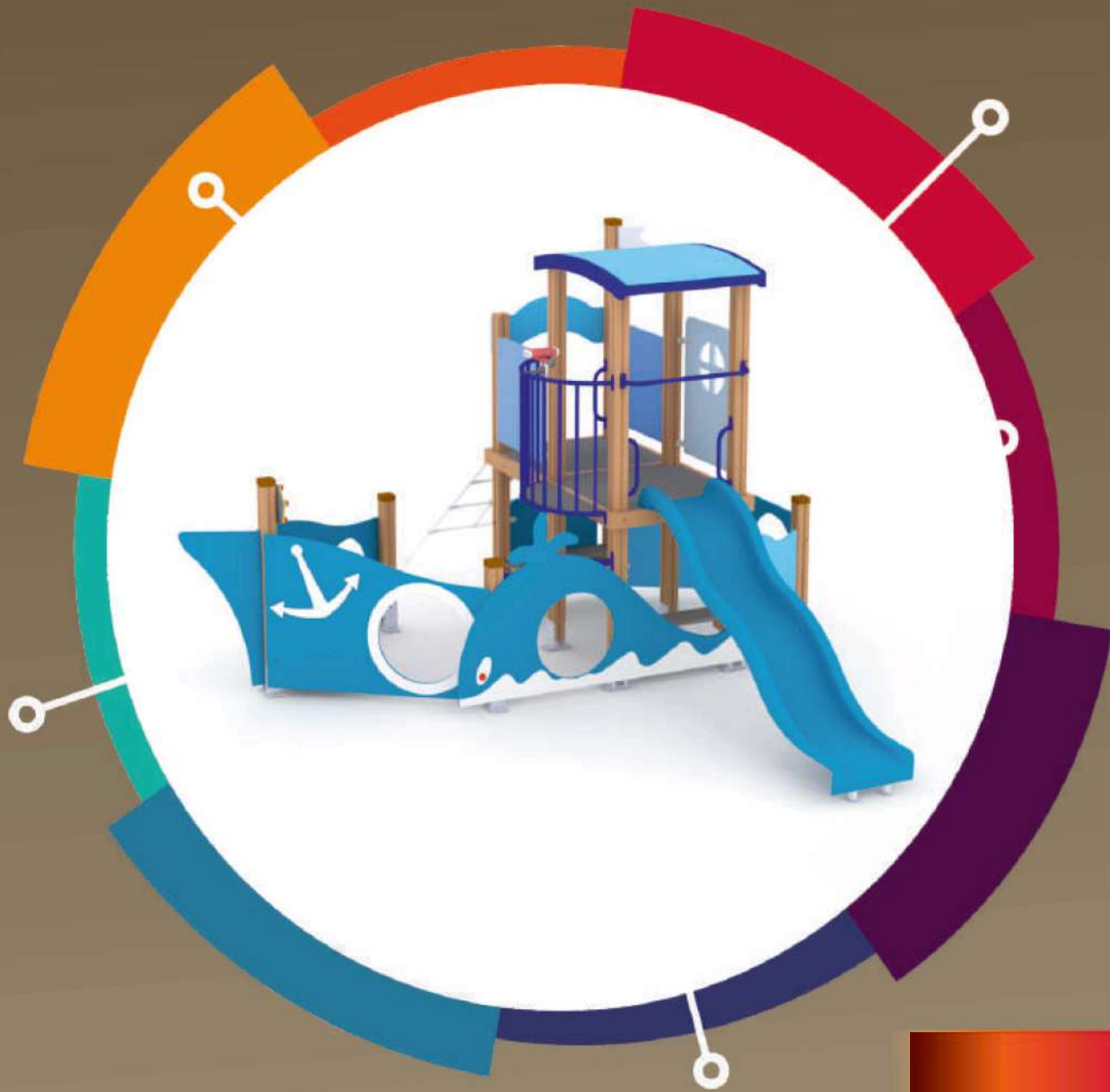

WOODEN THEME SERIES

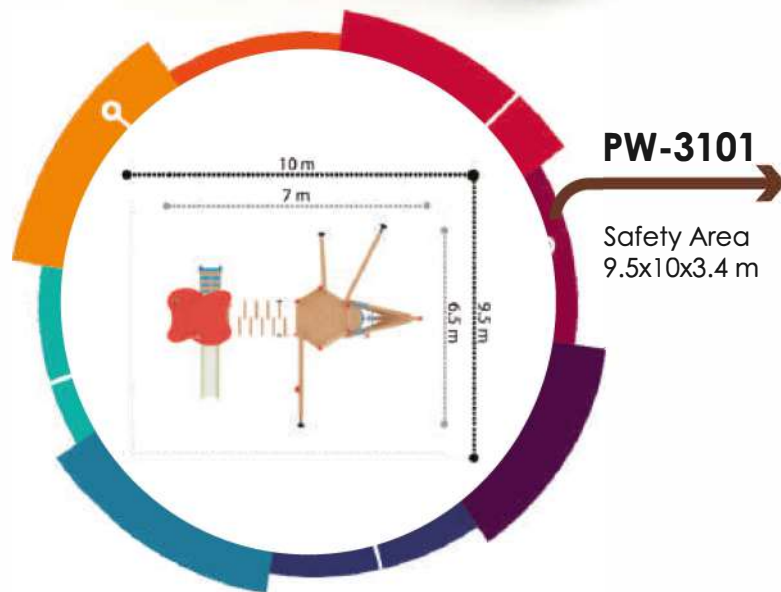
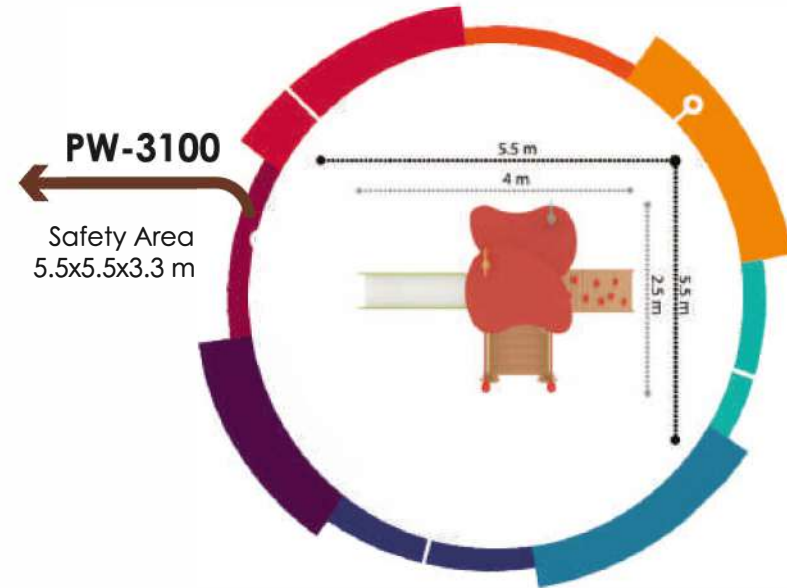

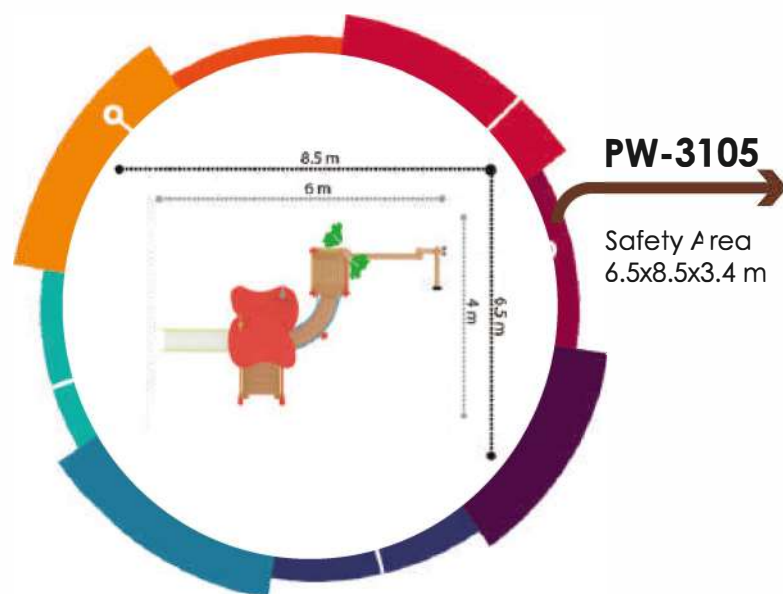
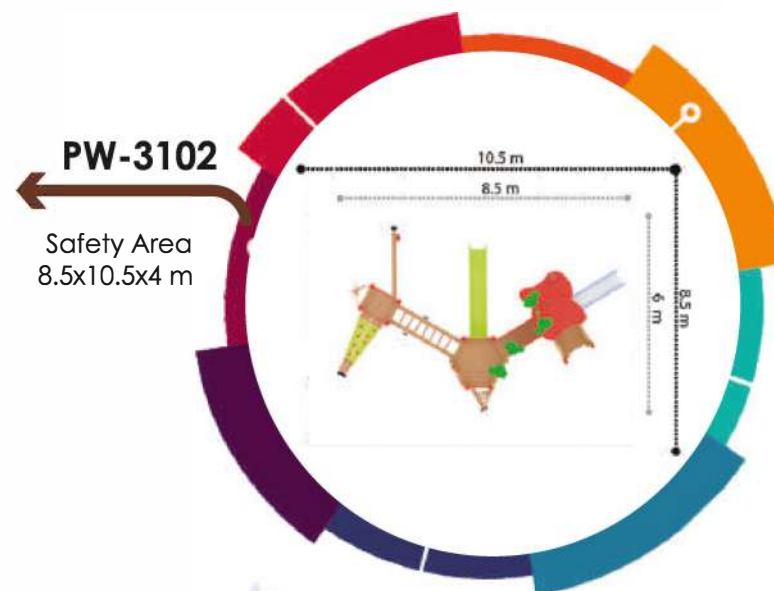



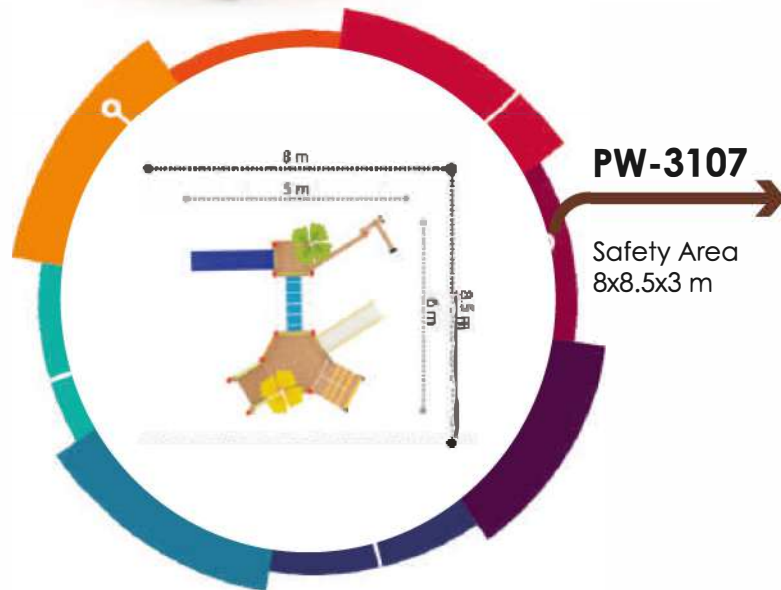
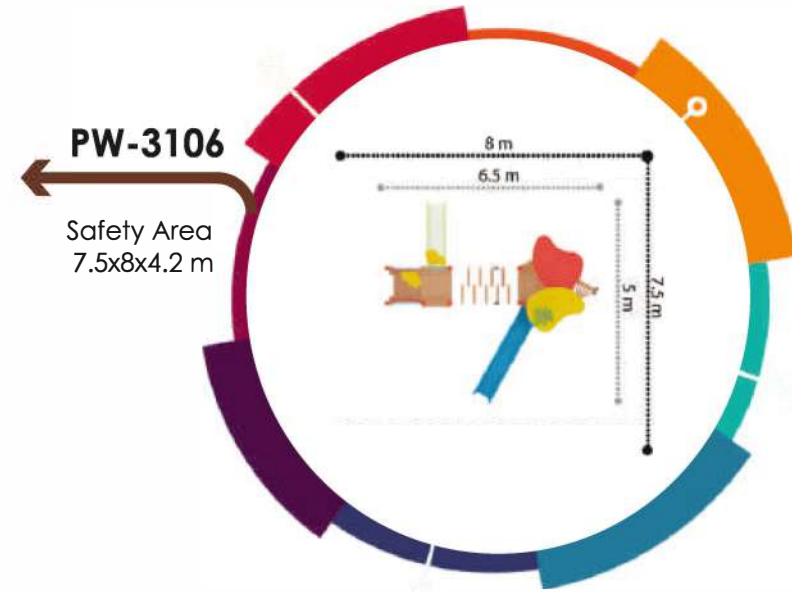



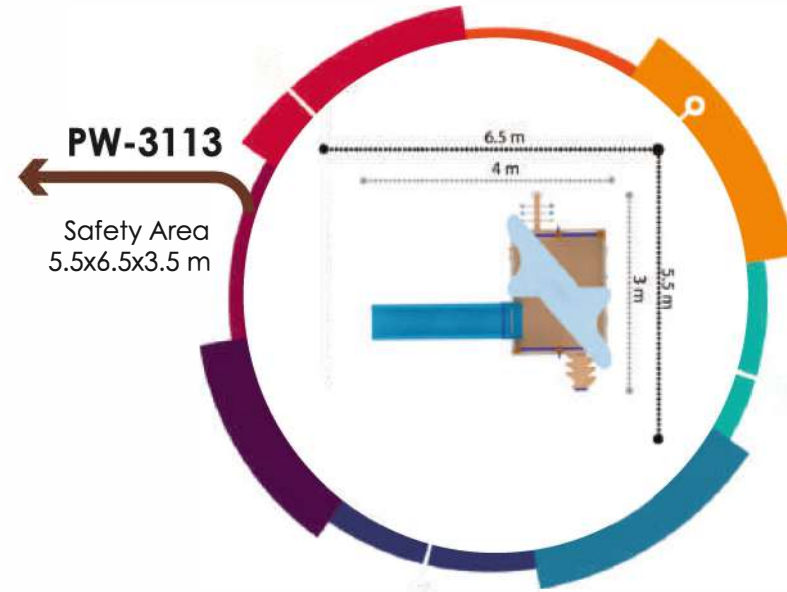

**PW-3113**

Safety Area  
5.5x6.5x3.5 m

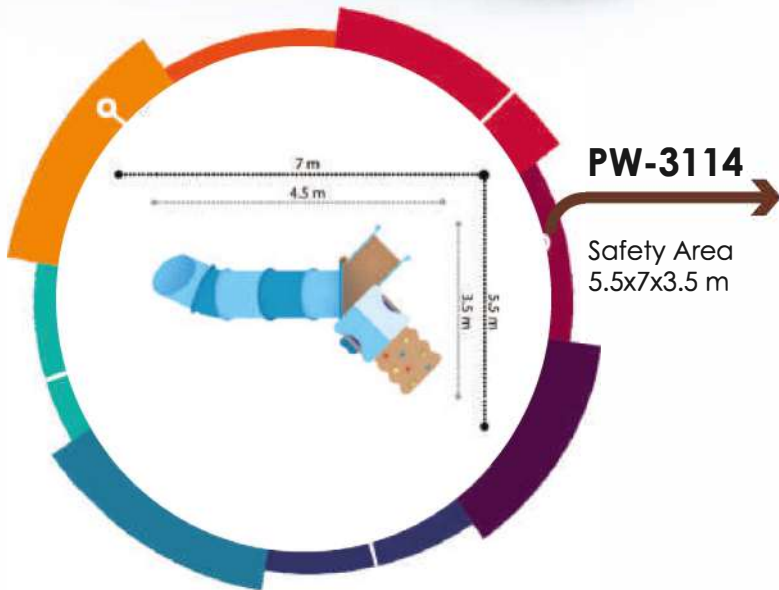

**PW-3114**

Safety Area  
5.5x7x3.5 m







MONTE EXPRESS

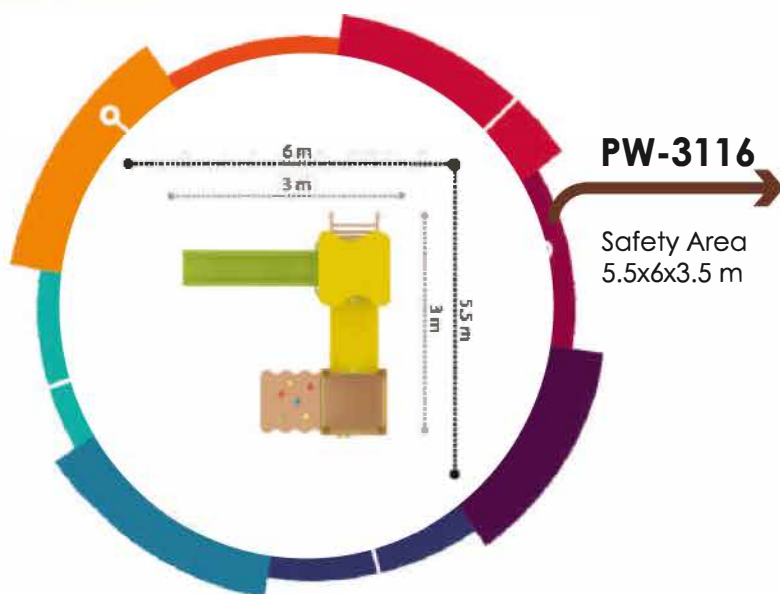
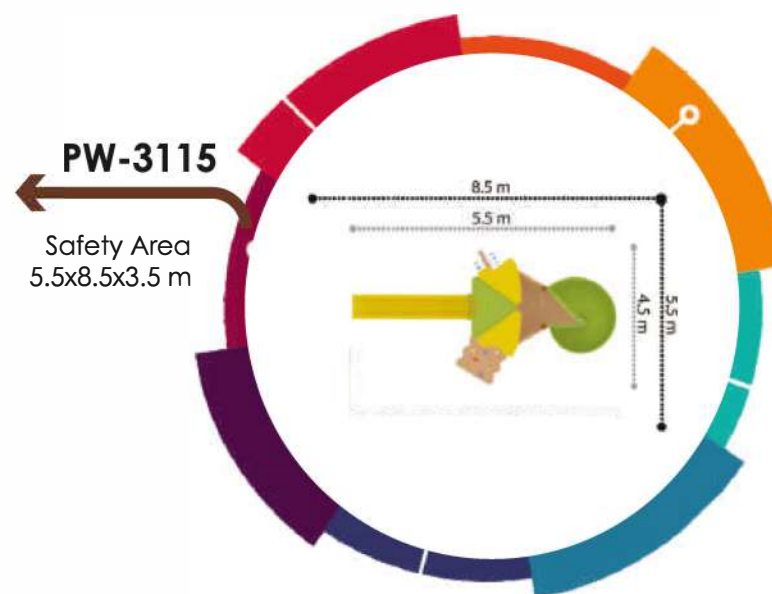

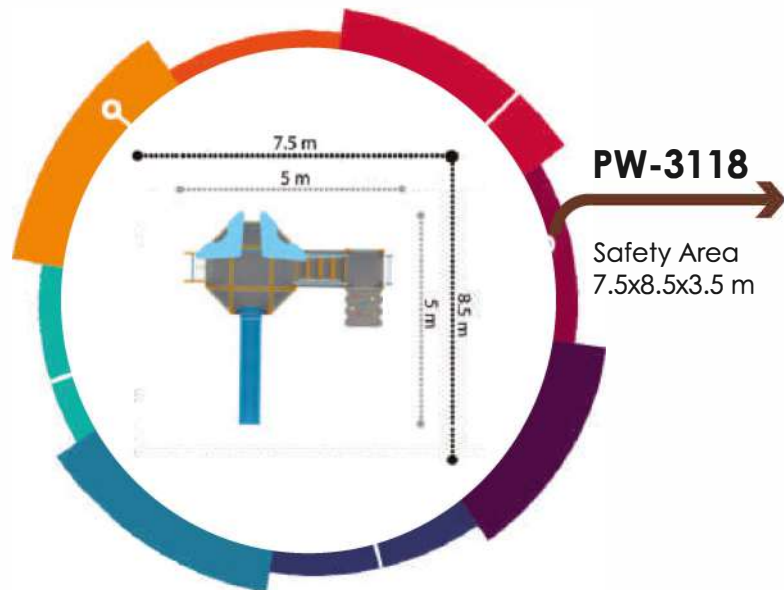
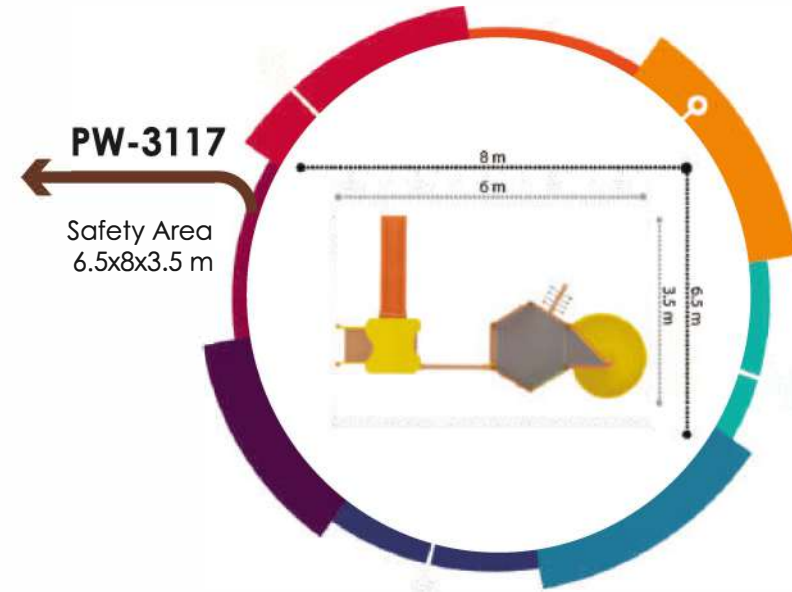



MONTE EXPRESS

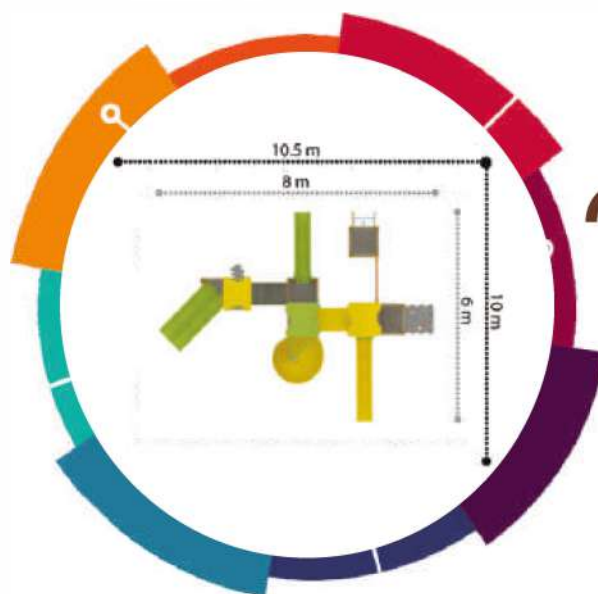
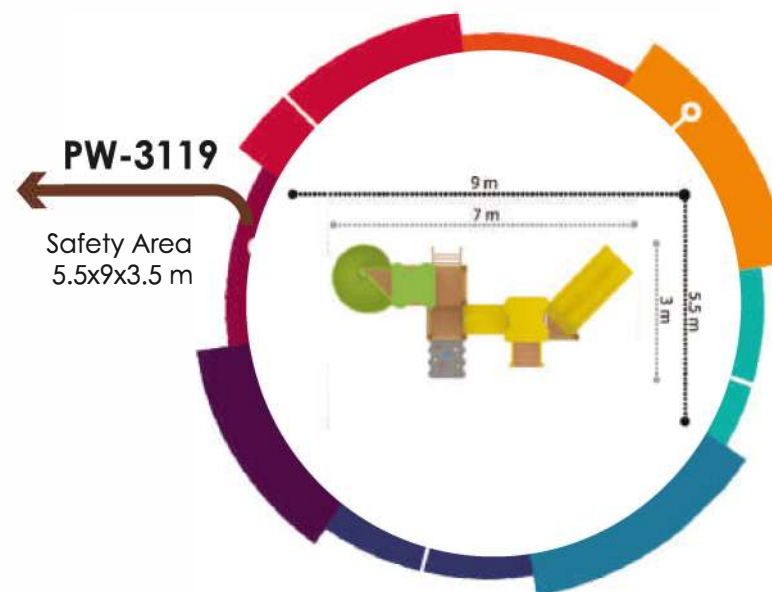

**PW-3120**

Safety Area  
10x10.5x3.5 m





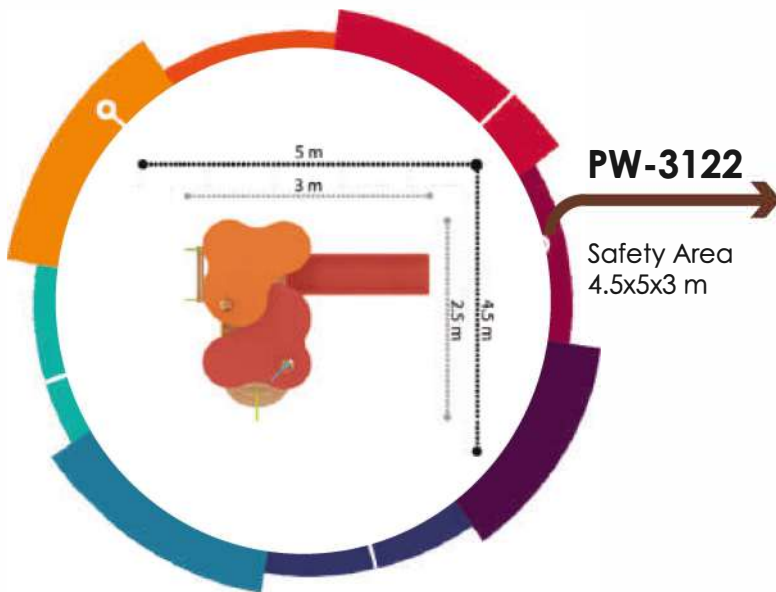
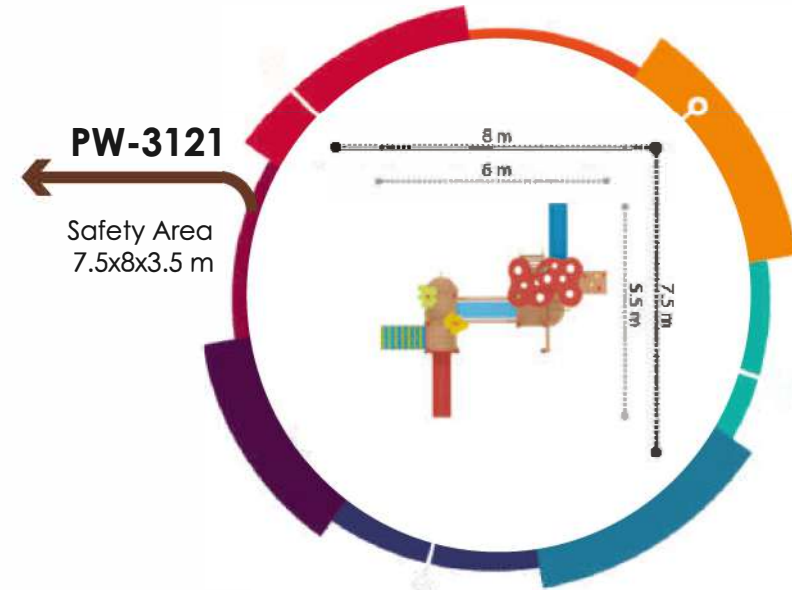

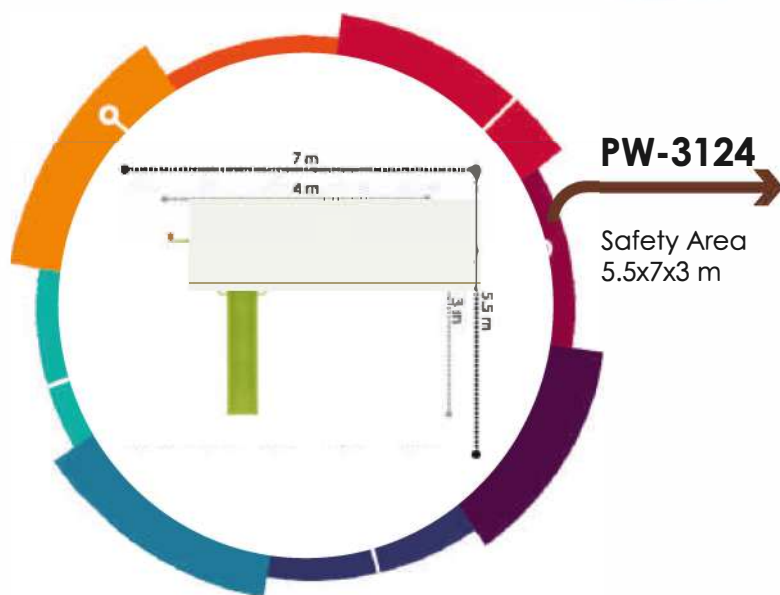
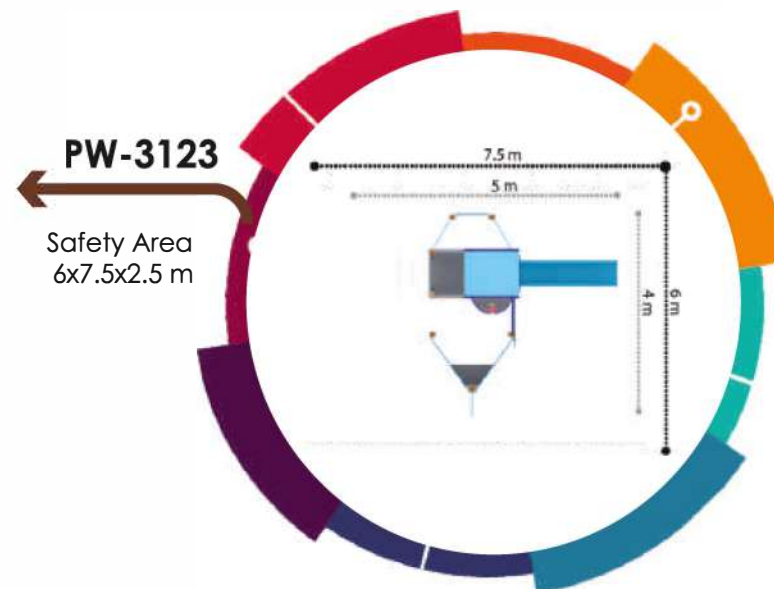

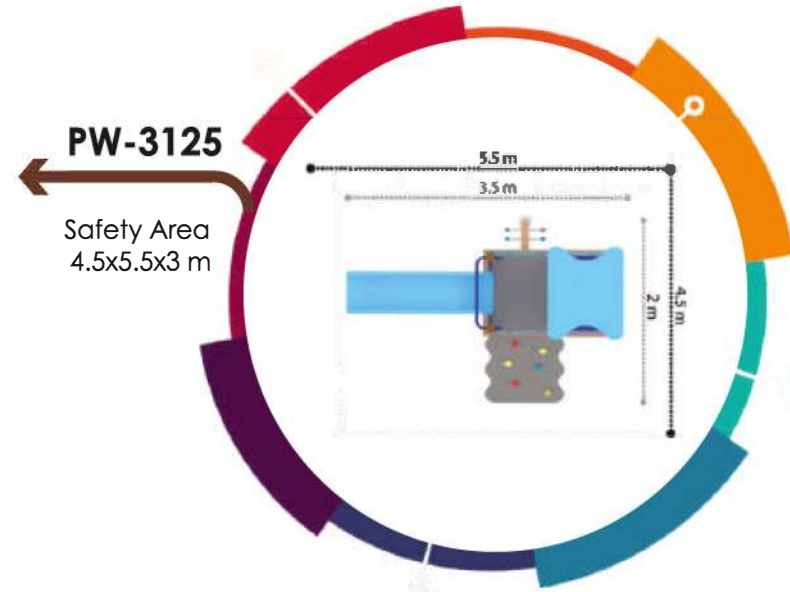

**PW-3125**

Safety Area  
4.5x5.5x3 m

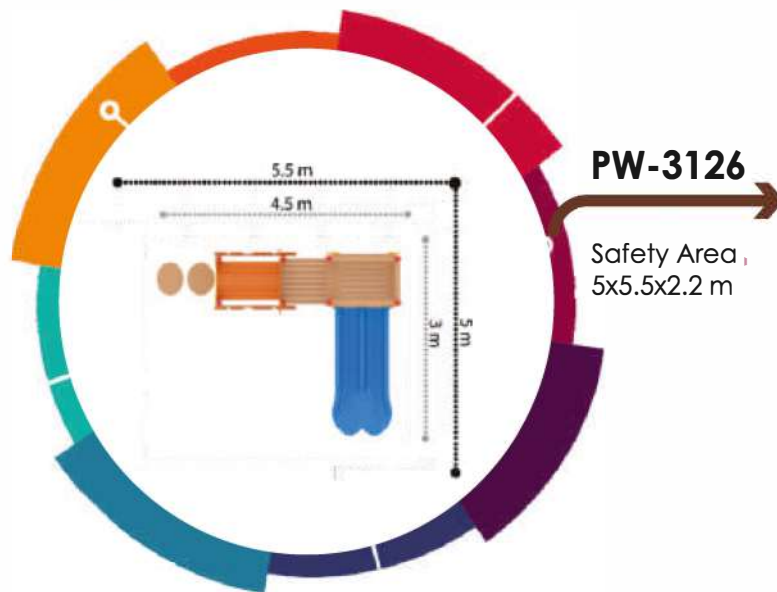

**PW-3126**

Safety Area  
5x5.5x2.2 m





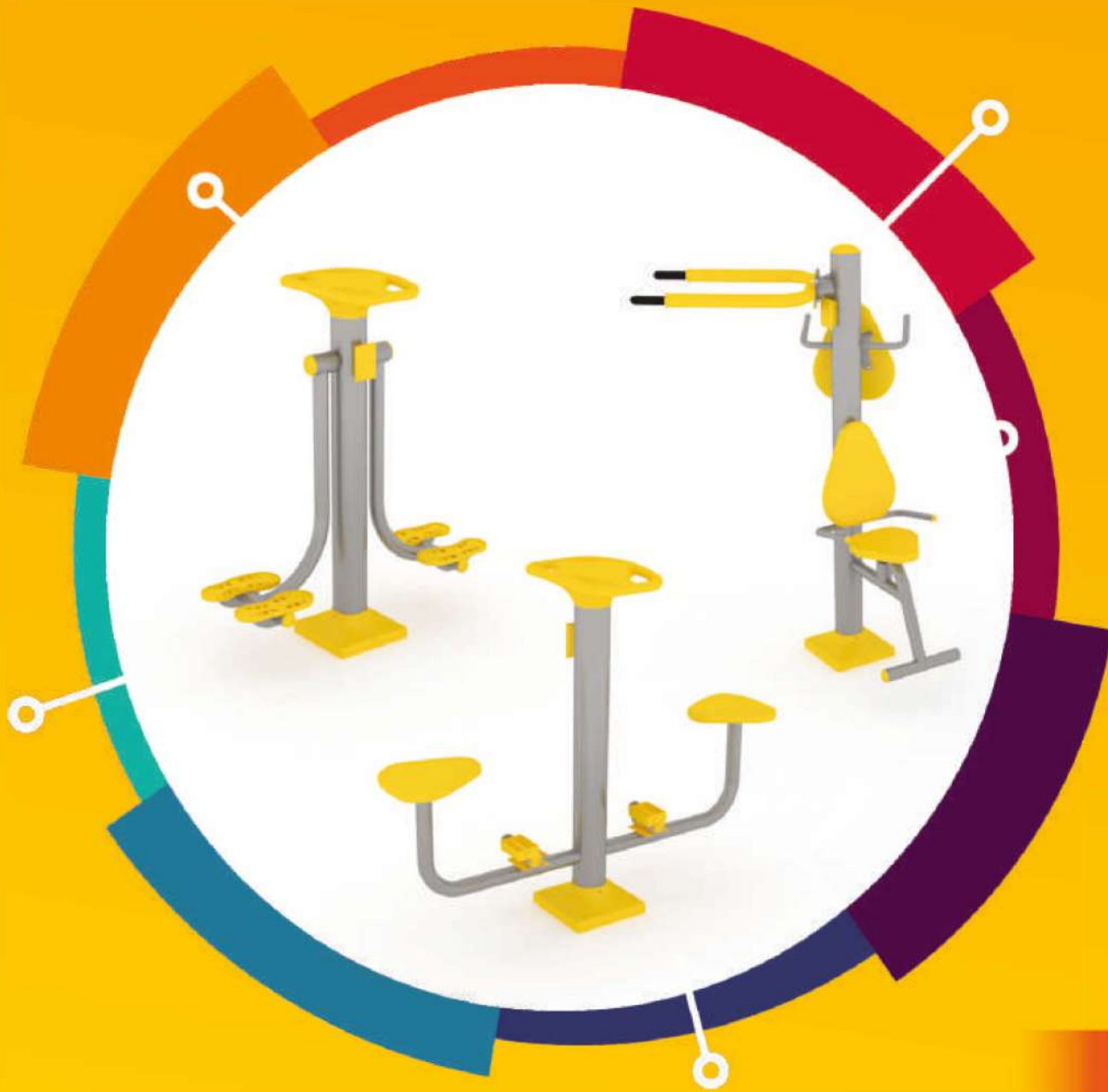

SPORT EQUIPMENTS



**PW-1600**

Shuttlele



**PW-1602**

Air Walking



**PW-1604**

Binary Bicycle



**PW-1606**

Pendulum



**PW-1608**

Body Building



**PW-1610**

Leg Push



MONTE EXPRESS



**PW-1612**

Scissors



**PW-1614**

Arm Training



**PW-1616**

Binary Walk



**PW-1618**

Back Stretch



**PW-1620**

Bicycle and Back Stretch



**PW-1622**

Step and Bicycle





**6'li (6 Pcs)**

Fitting Area  
50 m<sup>2</sup>

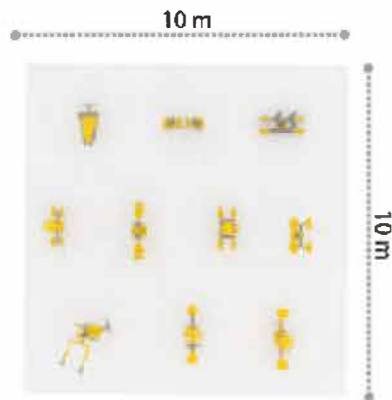

**12'li (12 Pcs)**

Fitting Area  
100 m<sup>2</sup>



## METAL FITNESS EQUIPMENTS



**PW-1650**

Leg Push



**PW-1652**

Lever



**PW-1654**

Binary Bicycle



**PW-1656**

Arm Training



**PW-1658**

Jockey



**PW-1660**

Pendulum





MONTE EXPRESS



**PW-1662**

Shoulder Wheel



**PW-1664**

Back Stretch



**PW-1666**

Elitcal Bicycle



**PW-1668**

Back Massage



**PW-1670**

Shuttlele



**PW-1672**

Air Walking



**PW-1690**

Safety Area  
8.5x9.5x2.5 m

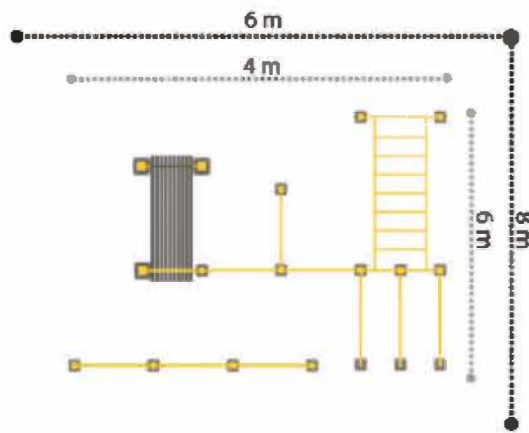
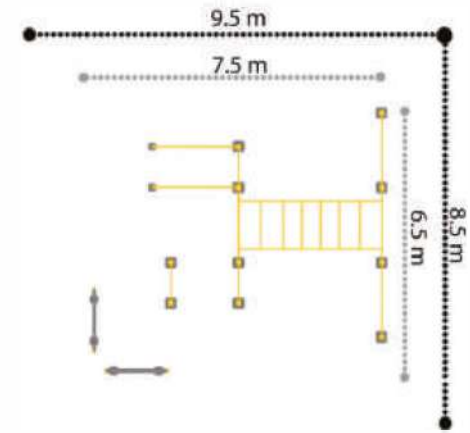

**PW-1691**

Safety Area  
6x8x2.5 m



URBAN FURNITURES





**PW-801**

Product Size  
162x55x80 cm

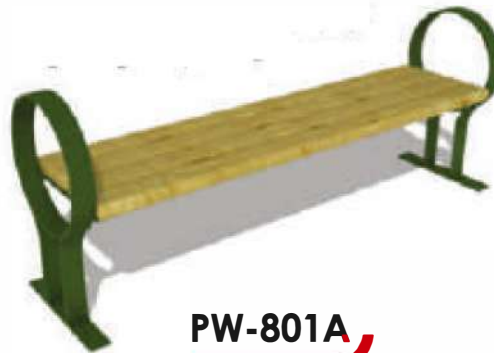

**PW-801A**

Product Size  
162x45x64 cm



**PW-802**

Product Size  
152x44x73 cm



**PW-803**

Product Size  
149x47x72 cm



**PW-805**

Product Size  
158x42x80 cm



**PW-806**

Product Size  
149x44x83 cm



**PW-807**

Product Size  
149x40x74 cm



**PW-808**

Product Size  
149x33x68 cm



**PW-809**

Product Size  
152x33x74 cm



**PW-810**

Product Size  
154x50x75 cm



**PW-811**

Product Size  
154x50x80 cm



**PW-813**

Product Size  
149x42x75 cm



**PW-814**

Product Size  
149x47x72 cm



**PW-815**

Product Size  
162x45x64 cm



**PW-816**

Product Size  
162x45x64 cm



**PW-817**

Product Size  
220x65x45 cm



**PW-818**

Product Size  
149x44x83 cm



**PW-819**

Product Size  
149x44x64 cm





**PW-01**

Octagonal Wooden Camellia



**PW-01A**

Hexagonal Wooden Camellia



**PW-02**

Square Wooden Camellia



**PW-03**

Octagonal Metal Camellia



**PW-03A**

Hexagonal Metal Camellia



**PW-04**

Square Metal Camellia



**PW-814**

Product Size  
182x149x74 cm



**PW-816**

Product Size  
183x150x75 cm



**PW-817**

Product Size  
180x150x75 cm



**PW-818**

Product Size  
170x150x215 cm



**PW-819**

Product Size  
280x202x235 cm



**PW-820**

Product Size  
240x184x225 cm



**PW-201**

Product Size  
37x72x30 cm



**PW-202**

Product Size  
37x67x30 cm



**PW-203**

Product Size  
37x72x30 cm



**PW-204**

Product Size  
37x72x30 cm



**PW-205**

Product Size  
37x67x30 cm



**PW-206**

Product Size  
37x72x30 cm





**PW-207**

Product Size  
37x75x30 cm



**PW-208**

Product Size  
37x75x30 cm



**PW-209**

Product Size  
37x72x30 cm



**PW-210**

Product Size  
37x72x30 cm



**PW-211**

Product Size  
41x67x28 cm



**PW-08**

Product Size  
25x25x74 cm



**PW-101**

Product Size  
106x43x49 cm



**PW-102**

Product Size  
89x45x49 cm



**PW-103**

Product Size  
108x43x49 cm



**PW-104**

Product Size  
64x44x49 cm



**PW-105**

Product Size  
75x44x49 cm



**PW-106**

Product Size  
106x43x49 cm



**PW-107**

Product Size  
86x44x49 cm



**PW-108**

Product Size  
106x43x49 cm



**PW-109**

Product Size  
102x43x42 cm



**PW-110**

Product Size  
102x43x49 cm



**PW-111**

Product Size  
77x42x54 cm



**PW-112**

Product Size  
64x44x49 cm





**PW-113**

Product Size  
82x44x49 cm



**PW-114**

Product Size  
77x40x69 cm



**PW-115**

Product Size  
115x43x40 cm



**PW-116**

Product Size  
109x51x44 cm



**PW-117**

Product Size  
80x36x58 cm



**PW-118**

Product Size  
103x50x30 cm





**PW-119**

Product Size  
103x35x30 cm



**PW-120**

Product Size  
100x80x37 cm



**PW-121**

Product Size  
93x45x33 cm



**PW-123**

Product Size  
102x45x38 cm



**PW-123A**

Product Size  
102x45x38 cm



**PW-125**

Product Size  
87x37x30 cm



**PW-402**

Product Size  
78x147x66 cm



**PW-406**

Product Size  
78x144x66 cm



**PW-407A**

Product Size  
66x31x103 cm



**PW-407B**

Product Size  
66x31x103 cm



**PW-408**

Product Size  
80x170x66 cm



**PW-411**

Product Size  
110x60x100 cm







**PW-416**

Product Size  
106x80x80 cm



**PW-417**

Product Size  
106x150x31 cm



**PW-418**

Product Size  
135x150x44 cm



**PW-419A**

Product Size  
93x33x64 cm



**PW-420**

Product Size  
75x25x77 cm



**PW-423**

Product Size  
110x40x91 cm

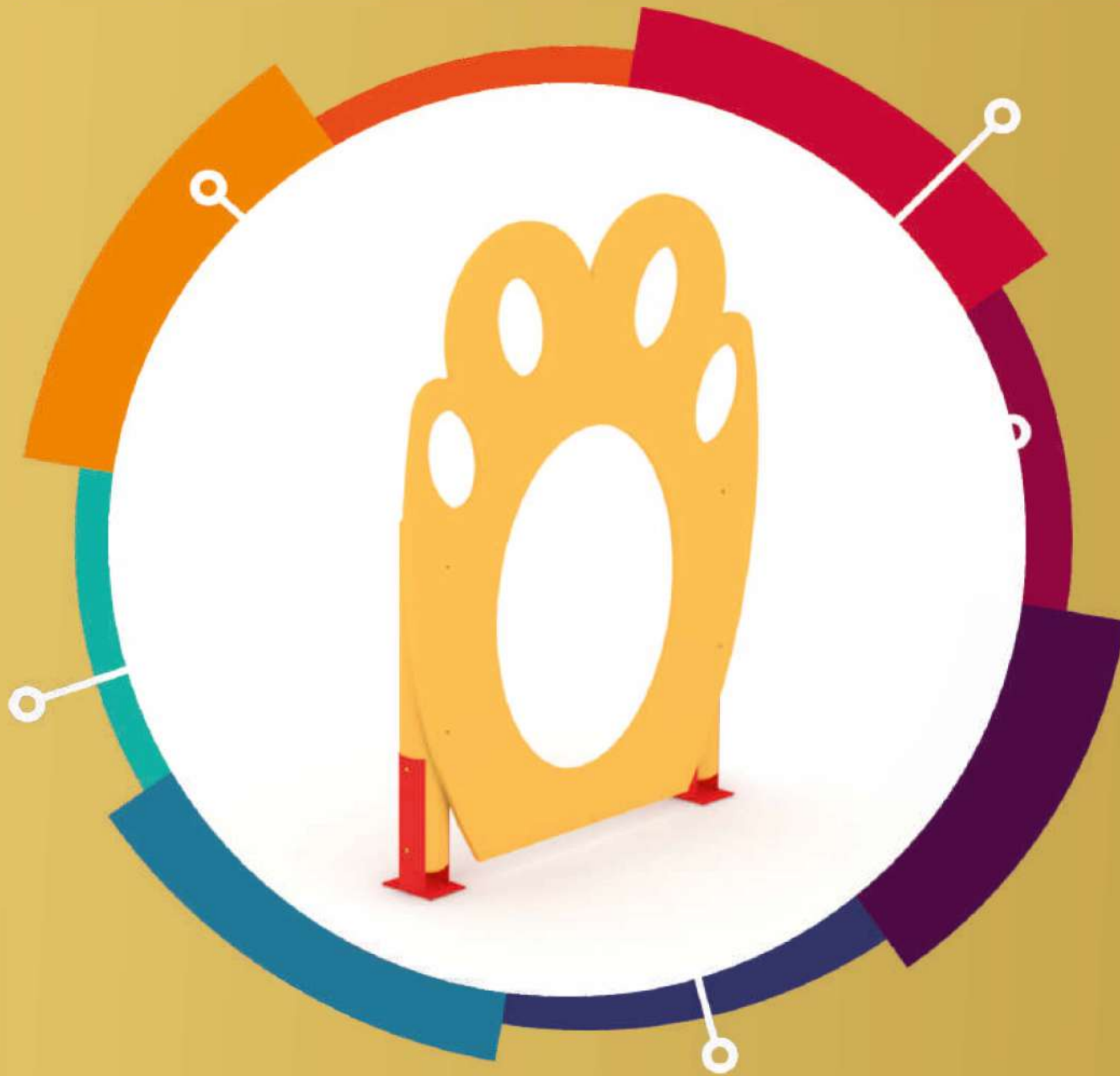

DOG TRAINING EQUIPMENT



**PW-701**  
(Balance Board)



**PW-702**  
(Walking Balance)



**PW-703**  
(Walking Balance)



**PW-704**  
(Jumping Iron)

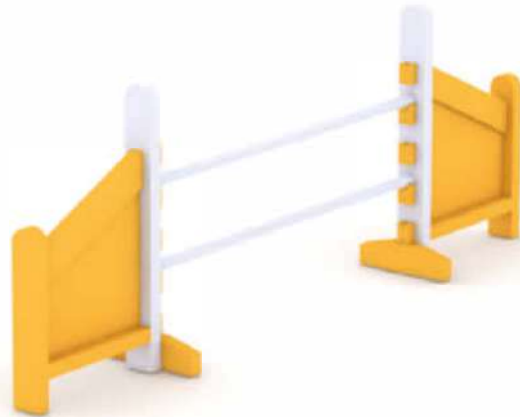

**PW-705**  
(Double Jumping Iron)

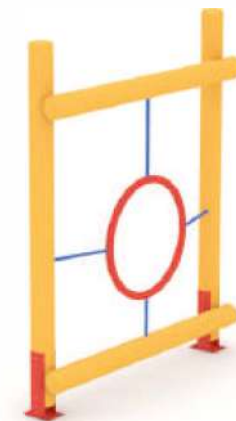

**PW-706**  
(Circle Jumping)





**PW-707**

(Paw Circle)

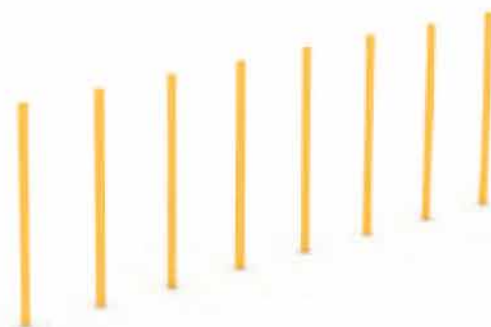

**PW-708**

(Slalom Sticks)

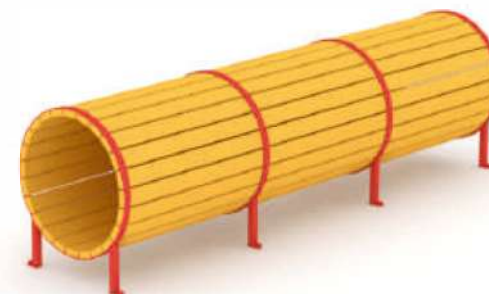

**PW-709**

(Long Dog Tunnel)



**PW-710**

(Jumping Board)



**PW-711**

(Home Tunnel)

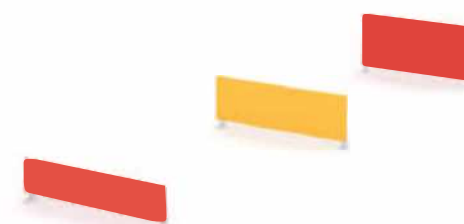

**PW-712**

(Track Level Boards)







**PW-30**

Game House Two  
Doors 120x106x90 cm



**PW-25**

Small Bench  
105x72x50 cm



**PW-26**

Chair  
72x45x50 cm



**PW-27**

Small Chair  
56x34x35 cm



**PW-28**

Sand Table  
54x90 cm



**PW-29**

Table with Plastic  
Leg 120x55x60 cm

## SOFTPLAY PRODUCTS



**PW-31**

Game House Single Door  
115x106x90 cm



**PW-32**

Playhouse Two Doors With Slide  
115x106x90 cm



**PW-33**

Caterpillar Seesaw  
45x133 cm

**PW-34**

Trojan horse  
55x70 cm



**PW-35**

Swinging Elephant  
54x92 cm

**PW-36**

Little Dog  
55x71 cm





**PW-01**

Basketball Hoop  
117x177x52 cm



**PW-02**

Football Goal  
64x117x80 cm



**PW-03**

Fence  
60x47 cm

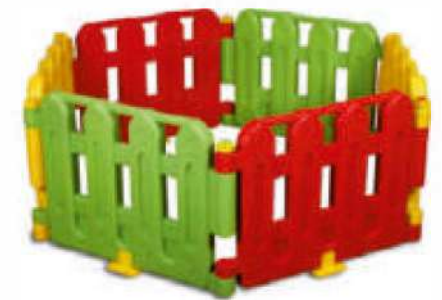

**PW-03A**

Fence  
80x60 cm



**PW-03B**

Fence  
40x80 cm



**PW-04**

Round Activity  
145x45 cm



**PW-05**

Square Playground  
138x51 cm



**PW-06**

Ringo  
40x23x12 cm



MONTE EXPRESS



**PW-07**

Dolphin Slide  
122x210x43 cm



**PW-08**

Slides  
95x129x38 cm



**PW-09**

Cute Teddy Swing  
148x85x90 cm



**PW-10**

Cute Teddy Swing with Slide Set A  
148x145x43 cm



**PW-11**

Cute Teddy Slide Swing Set B  
230x148x43 cm



**PW-12**

Cute Teddy Swing with Slide Set C  
205x145 cm



**PW-13**

Swing  
122x72 cm



**PW-14**

Chain Swing  
126x55 cm



**PW-15**

Corded Bead Swing  
126x55 cm



**PW-16**

Crucible Slide  
122x198x43 cm



**PW-17**

Slide Set B  
122x198x43 cm



**PW-18**

Slide Set B  
122x231x43 cm



**PW-19**

Slide Set C  
122x231x43 cm



**PW-20**

House With Slide Swing  
160x190x33 cm



**PW-21**

Home Big Set  
160x242x90 cm



**PW-22**

Storage Rack  
91x94x38 cm



**PW-23**

Bookshelf  
80x80x41 cm



**PW-24**

Multi Purpose  
Rack 91x94x38 cm



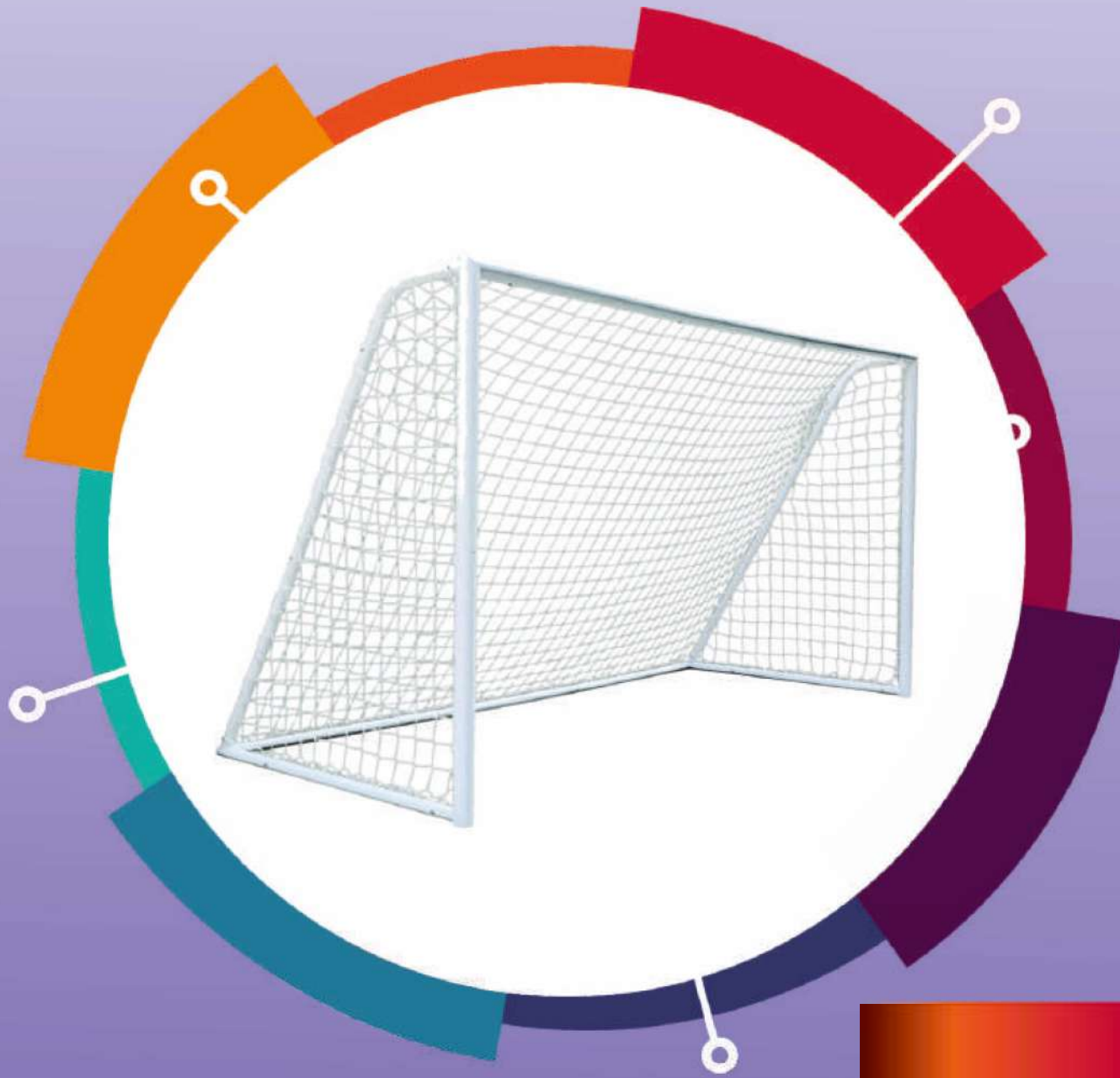

FIELD EQUIPMENTS



**PW-908**

Miniature Football Goal  
100x160 cm



**PW-909**

Football Goal  
200x300 cm



**PW-910**

Substitute Bench



**PW-911**

Football Goal  
244x272 cm

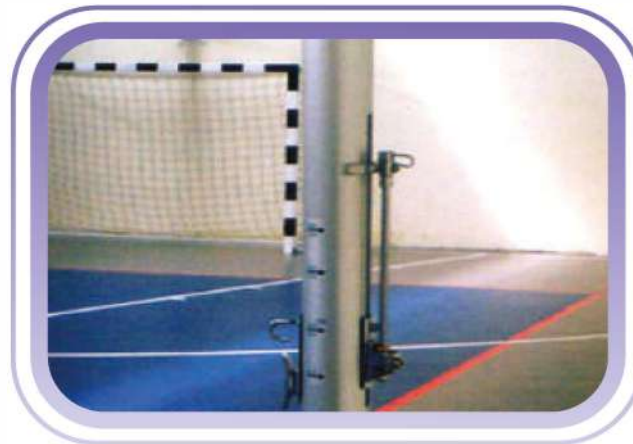

**PW-912**

Height Adjustable Volleyball Pole



**PW-913**

Tennis Pole





**PW-901**

Single Pole Basketball Hoop



**PW-902**

Four Pole Basketball Hoop



**PW-904**

200x300 cm Goal Above Hoop



**PW-905**

NBA Type Basketball Hoop



**PW-906**

Triple Basketball Hoop



**PW-907**

Wall-Mounted Basketball Hoop





SINGLE FENCE PANEL



DOUBLE FENCE PANEL



WELDED WIRE FENCE

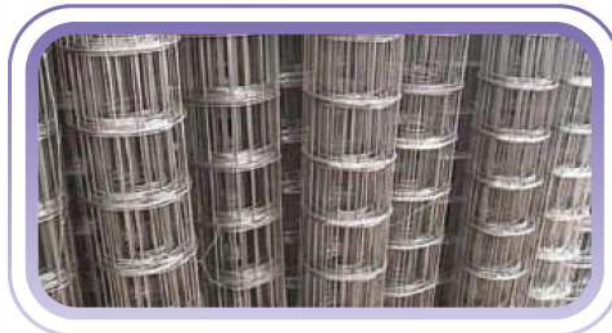



STRAIGHT-LINE RAZOR WIRE



SPIRAL RAZOR WIRE



FLAT WRAP RAZOR WIRE





CHAINLIK MESH



GABION BASKET



SPORT FIELDS GATES







PROJECT APPLICATION

*My Project*



*My Project*



*My Application*



*My Application*







MONTE EXPRESS











MONTE EXPRESS

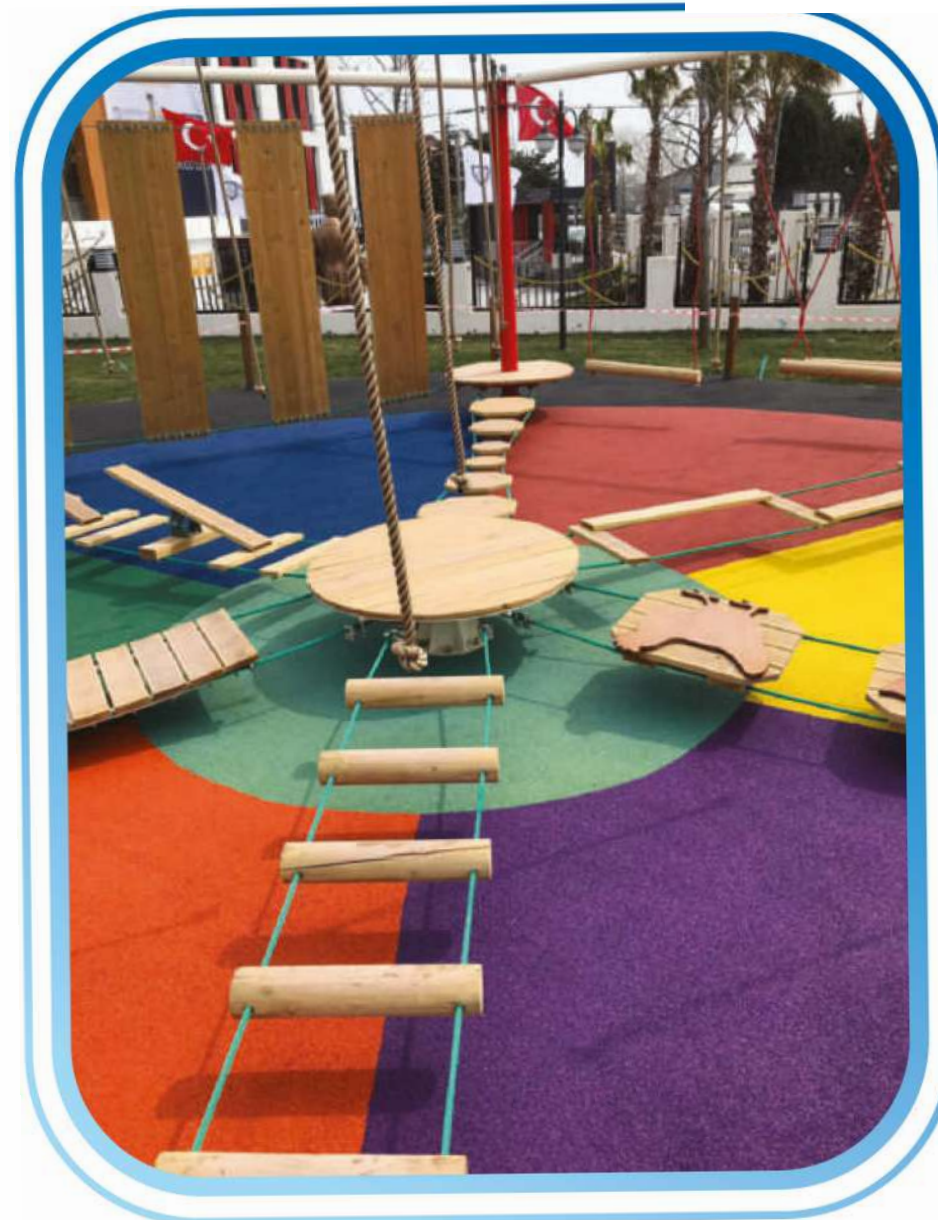









MONTE EXPRESS











MONTE EXPRESS







MONTE EXPRESS

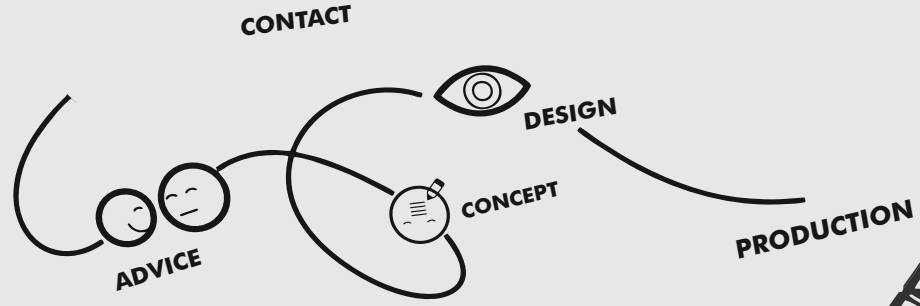

MONTE EXPRESS

Dış Ticaret



İstanbul / Türkiye



+90 0542 247 37 55



[www.monte-express.com](http://www.monte-express.com)

✉ [office@monte-express.com](mailto:office@monte-express.com)

✉ [info@monte-express.com](mailto:info@monte-express.com)

✉ [aldemir@monte-express.com](mailto:aldemir@monte-express.com)

